



International Stakeholder Dialogue on Pulse Fisheries

Report of the second dialogue meeting, Amsterdam 20 January 2017

Authors: Nathalie A. Steins¹, Sarah Smith¹, Wouter Jan Strietman², Brita Trapman³, Marloes Kraan¹

Wageningen University &
Research Report C016/17

¹ Wageningen Marine Research ² Wageningen Economic Research ³ Nederlandse Vissersbond

International Stakeholder Dialogue on Pulse Fisheries

Report of the second dialogue meeting, Amsterdam 20 January 2017

Author(s): Nathalie A. Steins¹, Sarah Smith¹, Wouter Jan Strietman², Brita Trapman³, Marloes Kraan¹

¹ Wageningen Marine Research ² Wageningen Economic Research ³ Nederlandse Vissersbond

Publication date: 7th March 2017

This research project was carried out by Wageningen Marine Research at the request of and with funding from the Ministry of Economic Affairs for the purposes of Policy Support Research Theme 'Sustainable fisheries -Pulse fisheries and landing obligation' (project no. BO-20.010-078).

Wageningen Marine Research
IJmuiden (Netherlands), March 2017

Wageningen Marine Research report C016/17

Nathalie A. Steins¹, Sarah Smith¹, Wouter Jan Strietman², Brita Trapman³, Marloes Kraan¹.
International Stakeholder Dialogue on Pulse Fisheries; Report of the second dialogue meeting,
Amsterdam 20 January 2017. Wageningen, Wageningen Marine Research (University & Research
centre), Wageningen Marine Research report C016/17, 145 pp.

Affiliations: ¹ Wageningen Marine Research ² Wageningen Economic Research ³ Nederlandse
Vissersbond

Keywords: pulse fisheries, pulse trawl, stakeholder engagement, Common Fisheries Policy, technical
measures

Client: Ministry of Economic Affairs
Attn.: Kees Verbogt
Postbus 20401
2500 EK Den Haag, Netherlands

BO-20-010-78

This report can be downloaded for free from [http: https://doi.org/10.18174/409684](http://https://doi.org/10.18174/409684)
Wageningen Marine Research does not provide hard copies of reports

Wageningen Marine Research is ISO 9001:2008 certified.

© 2017 Wageningen Marine Research Wageningen UR

Wageningen Marine Research
institute of Stichting Wageningen
Research is registered in the Dutch
traderecord nr. 09098104,
BTW nr. NL 806511618

The Management of Wageningen Marine Research is not responsible for resulting
damage, as well as for damage resulting from the application of results or
research obtained by Wageningen Marine Research, its clients or any claims
related to the application of information found within its research. This report
has been made on the request of the client and is wholly the client's property.
This report may not be reproduced and/or published partially or in its entirety
without the express written consent of the client.

Contents

Summary	4
1 Introduction	5
2 Report of the Second International Pulse Stakeholder Dialogue Meeting	6
2.1 Plenary session	6
2.1.1 Opening	6
2.1.2 NGO perspective	6
2.1.3 Closed session	7
2.2 Breakout sessions	9
2.2.1 Into the working of pulse fishing – transition beam/pulse and scale models	9
2.2.2 Break out session 2: Setting the scene – research in hindsight and forecast	13
2.2.3 Control & Enforcement – lessons learnt and developments	15
2.2.4 Elaboration – Scope and regionalisation within EU – broader scope	19
2.3 Conclusions	25
3 Quality Assurance	26
References	27
Justification	28
Annex 1 List of participants	29
Annex 2 Presentation Lotte Huisman: NGO perspective	31
Annex 3 Presentation Pim Visser: Developments Dutch flatfish fleet	37
Annex 4 Presentation Harmen Klein Wolthuis: The pulse system	61
Annex 5 Presentation Adriaan Rijnsdorp: Pulse research in hindsight and forecast	86
Annex 6 Presentation Richard van Buuren: Control & enforcement pulse fishery	108
Annex 7 Presentation Kees Verbogt: Scope and regionalisation	128
Annex 8 Technical requirements pulse trawl	142

Summary

This document is a report of the Second International Pulse Stakeholder Dialogue meeting hosted by the Dutch Ministry of Economic Affairs in Amsterdam on 20 January 2017. The report contains the minutes of the plenary and open sessions. The people listed as authors of the report have made these minutes. Hence, this document does not have the status of a research report. Participation and reporting was performed within the Policy Support Research programme (*Beleidsondersteunend Onderzoek*), theme 'Sustainable fisheries -Pulse fisheries and landing obligation' of the Ministry.

The dialogue meeting on pulse fisheries was organised in the context of the Dutch Ministry of Economic Affairs approach to engage in a more transparent and inclusive process concerning the benefits, questions and concerns about the development of pulse fisheries. Since the first international dialogue meeting in 2015, a multi-annual research programme into the impacts of flatfish pulse fishing has started. An International Science Advisory Committee (ISAC) has been established to examine the research process and the quality of science produced (peer review) and assist the scientists involved and the government to identify where gaps exist and address these in innovative ways. In addition, steps have been taken in relation to control and enforcement.

Over 80 participants from 8 different countries attended the dialogue meeting. They represented government bodies, political parties, fishers, processors and traders, NGOs, standards holders and scientists. Discussions were held under Chatham House Rules and so is this report.

During the meeting four parallel breakout sessions were held:

1. Into the working of pulse fishing – transition beam/pulse and scale models (section 2.2.1)
2. Setting the scene – research in hindsight and forecast (section 2.2.2)
3. Control & Enforcement – lessons learnt and developments (section 2.2.3)
4. Elaboration – Scope and regionalisation within EU – broader scope (section 2.2.4)

From the break out groups and plenary discussions, ISAC identified the following key points:

1. A key question is when the scientific evidence is enough to move forward. Another workshop with a cross-section of people may be needed to address this question.
2. What level of uncertainty and risk are we prepared to accept? It is important to ensure that legislation is flexible enough so that regulations can be undone when one gets it wrong.
3. The way pulse fishing currently takes place in the Netherlands is a large experiment with a large fleet. It is important that scientists use this situation to maximise the opportunities the commercial fleet offers in collecting data.
4. There is the issue of control and enforcement. The control and enforcement team seems comfortable they can deal with it, but there will always be an arms race. This question is whether this can be prevented and one can be confident about this.
5. Innovation in the future should be possible. If the limits of the gears are set too hard, then this should not hamper further innovation and improvements.
6. In relation to the question of animal welfare, it is important that the research informs the debate on how many fish are subjected to injury relative to fish that would die anyway, so that it is put in perspective.
7. One has to be careful how to translate the science. For example, there is a question on whether or not pulse trawling drives fish away; fishing with a mechanical bottom-trawl, will cause mortality of benthos which increases food availability for fish. There is a point where science stops and politics comes in. What people see depends on their perspective and how they translate it.
8. The Dutch industry wants to be innovative. It would be useful if the European Commission would develop a manual or guidelines about the type of information that needs to be collected. Without a protocol it is difficult to make an agreed decision.

1 Introduction

This document is the report of the Second International Pulse Stakeholder Dialogue meeting hosted by the Dutch Ministry of Economic Affairs in Amsterdam on 20 January 2017. The report comprises elaborate minutes of the plenary and open sessions. The people listed as authors of the report have made these minutes. Hence, this document does not have the status of a research report.

It was decided to use a Wageningen Marine Research report format for this report, in order for the dialogue results to be easily and transparently available for future use in the research and policy process.

The discussions were held in accordance with so-called Chatham House Rules, which means that comments cannot be attributed to individual names. An exception has been made for the presenters (in relation to their own presentation) and scientists who are quoting their own work. Their names are disclosed in the report. There is no reference to participants' nationalities in the report, except when it concerns representatives from the Dutch government or Dutch fishing industry. This is done with their permission and in view of accountability and transparency considerations upheld by these parties.

Participation and reporting was performed within the Policy Support Research programme (*Beleidsondersteunend Onderzoek*), theme 'Sustainable fisheries -Pulse fisheries and landing obligation', of the Ministry of Economic Affairs.



International Pulse Stakeholder Dialogue Meeting, 20 January 2017

2 Report of the Second International Pulse Stakeholder Dialogue Meeting

2.1 Plenary session

2.1.1 Opening

Marieke Mossink, Fisheries Director at the Dutch Ministry of Economic Affairs welcomes a broad range of participants from eight countries to the dialogue meeting (for participant lists, see annex 1). She acknowledges that the Dutch are proud of the pulse trawl and consider it to be a sustainable alternative to the traditional beam-trawl. The Dutch have optimised the technique. But in the process, they forgot to take along the stakeholders and have not been so transparent. In their ambition, they have pushed on the development side of the trawl and getting the legislative approval. It appeared, however, that different groups of stakeholders from other countries had concerns; for example on impacts of fishing with electricity on marine organisms and control and enforcement. The Ministry of Economic Affairs therefore decided on a new approach that focusses on being transparent on benefits, questions and concerns. This process was started in July 2015 with the first international dialogue meeting held in Scheveningen. Many of the questions and concerns raised at that meeting then fed into the multi-annual research programme that is currently being carried out. In addition to the research side, a lot has happened on technique and on control and enforcement.

At this dialogue meeting there will be parallel breakout sessions on:

1. Into the working of pulse fishing – transition beam/pulse and scale models (section 2.2.1)
2. Setting the scene – research in hindsight and forecast (section 2.2.2)
3. Control & Enforcement – lessons learnt and developments (section 2.2.3)
4. Elaboration – Scope and regionalisation within EU – broader scope (section 2.2.4)

Following Marieke Mossink's welcome, Michel Kaiser takes the floor. He is the chair of the International Science Advisory Committee (ISAC) of the multi-annual pulse research programme. Michel will chair the dialogue meeting. A report of the meeting will be available and published on the pulse information website (www.pulsefishing.eu). He stresses that the discussion and the report will be in accordance with so-called Chatham House Rules, which means that comments cannot be attributed to individuals. In the report an exception will be made for the presenters (in relation to their own presentation) and scientists who are quoting their own work. Their names will be in the report. There will be no references to participants' nationalities in the report, except when speakers of the Dutch governments or Dutch fishing industry are concerned. This is done with their permission and in view of accountability and transparency considerations upheld by these parties.

Before the breakout sessions, there will be a presentation of NGO views on the pulse trawl followed by a closed discussion session.

2.1.2 NGO perspective

Lotte Huisman from North Sea Foundation presents an NGO perspective on pulse fishing, representing the joint views of Birdlife International, Greenpeace, Marine Conservation Society, Good Fish Foundation, NEV (Dutch Elasmobranch Association), ClientEarth, Environmental Defence Fund and WWF. The full presentation is available in annex 2 of the report.

Lotte Huisman stresses that this group of NGOs is in favour of innovation. The NGOs recognise that pulse has a reduced fuel consumption compared to the conventional beam trawl, less physical impact on the seabed and a potential for increased selectivity. But they also have concerns. First, there are still too many knowledge gaps concerning the ecological impacts. Second, effective control and enforcement seems lacking. Third, they question whether pulse fishing should be allowed in Natura

2000 areas. Four, they stress that irresponsible upscaling of the pulse fishery has damaged trust. Finally, they perceive a single-minded focus on pulse which seems to take attention away from exploring alternative gear innovations.

The group of NGOs feel that these problems should be addressed by the following actions. First, there should be no expansion of the pulse fisheries until the knowledge gaps have been resolved. Some NGOs feel that the current research programme does not address all their concerns fully, and Lotte Huisman mentions the importance of inclusion of all NGOs in the ongoing research programme so potential objections do not come as a surprise. Second, there should be effective control and enforcement. Third, access to Natura 2000 areas should be based on the outcome of an appropriate assessment and not negotiated beforehand. Fourth, transparency and stakeholder involvement are key. Roles should be clearly defined and input must be taken seriously. In this context, the group advocates that a protocol should be developed at the European level on how to deal with future innovations, i.e., a European-wide guideline to the steps that need to be undertaken when evaluating new approaches or technical innovations. Finally, an overview is needed on what alternatives have been tried or are being tried and how they compare to pulse. The group of NGOs stress that a clear vision is needed on the transition towards sustainable fisheries: this includes a joint definition of what sustainable fisheries are, how to get there and when to get there. Pulse fishing should be judged as part of this process and should not be the only gear that is held against this scrutiny. The presentation by the group leads to some questions and comments.

A scientist points out that science cannot solve all problems as each question will generate a new question. Also there will be different visions on when enough scientific results are available. He argues that one has to focus on risk management. The NGO community acknowledges this comment. This is why the North Sea Foundation has taken the lead to develop an NGO vision on which research is necessary and sufficient to resolve the current knowledge gaps.

Following a comment from the Dutch fishing industry, Lotte Huisman confirms that from the NGO group the North Sea Foundation has been part of the pulse steering group and as such has been involved from the beginning.

A representative from the fishing industry welcomes the views of the NGOs on innovation and poses a question on pulse fishing in relation to Natura 2000 areas in the North Sea, which are mostly sandbanks. His understanding is that assessment of these types of habitats shows that these sites are less sensitive. If one waits until the research is done before the pulse is allowed in these areas, the unintended consequence may be displacement to more sensitive areas. Representatives from the NGO's point out that displacement is always an issue in relation to Marine Protected Areas; there is no easy answer here but this issue has to be considered for N2000 sites. The Natura 2000 appropriate assessment is a very specific test to be met so the bar is necessarily higher.

2.1.3 Closed session

Following the NGO presentation there is a closed session with the International Science Advisory Committee (ISAC). Before the closed session starts, all Dutch government staff are asked to leave the room. The ISAC felt that participants should have the opportunity to raise any questions and concerns without feeling uncomfortable by the presence of Dutch government representatives.

The session starts with a short introduction of the ISAC members. Michel Kaiser stresses that it is impossible to address every single problem or concern. However, it is possible to prioritise the most important problems. The multiannual research programme already addresses some of these. The ISAC's role as an external party is to examine the research process and the quality of science produced (peer review) and to help the scientific groups involved and government to identify where the gaps exist and address these in innovative ways (Figure 1). Michel Kaiser is managing expectations. Stakeholders should not expect money to fall from the ceiling to study all problems, but there can be innovations through for example master studies or additional funds (foundations). It is a must to be creative but the science can only be creative if one knows what the questions are. The ISAC has an important role in channelling dialogue.

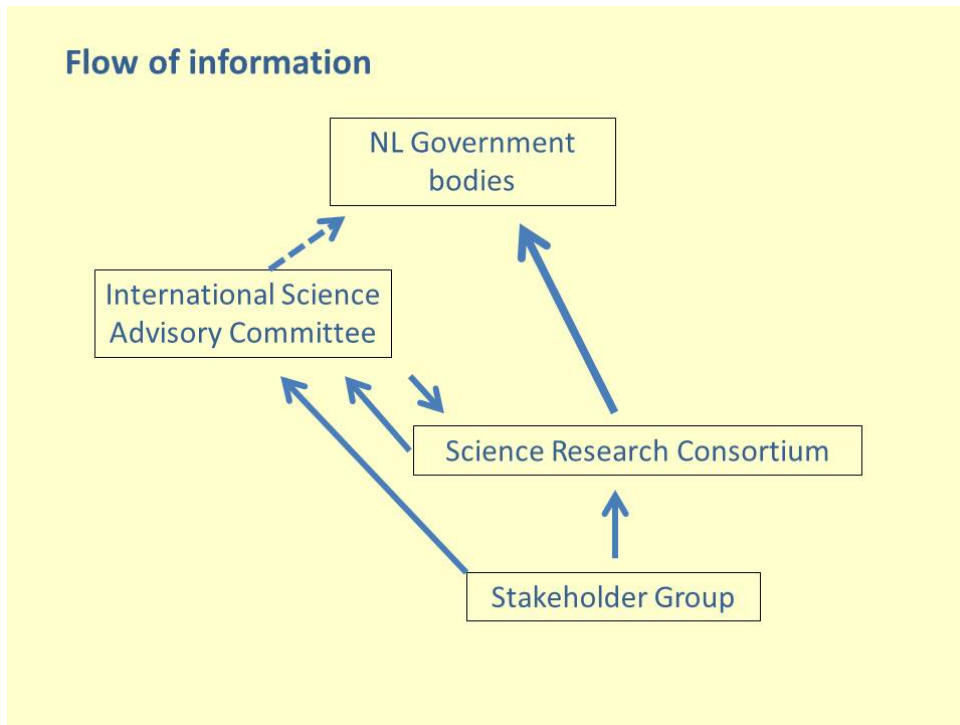

Figure 1: Schematic overview of position of ISAC

In November 2016, a questionnaire has been send out to the participants of the first dialogue meeting and other known interested stakeholders to make an inventory of research questions. Unless ISAC knows which are the shared priorities it is difficult for the committee to give advice on the priority problems. ISAC received only 9 responses while there are 85 in the room. This is not representative for the wide group of stakeholders. After this meeting a new questionnaire will be sent out. The responses will be collated and then ISAC intends to do a poll to find out the priorities. The initial themes emerging from the 9 respondents are: mortality of benthos, mortality of target and non-target fish, by-catch reduction, energy efficiency vs fish production and footprint of the fishery relative to the traditional beam trawl fleet. This closed session is also important to get stakeholder input.

Michel Kaiser's introduction leads to a number of observations on missing topics:

- The latest ICES advice on pulse makes clear that effective enforcement and control is a concern [comment from policy representative];
- Animal welfare is not included [from scientific community];
- Is it possible to do a post fishery assessment and compare before and after. Is there a sufficient beam trawl baseline? [from fishing industry];
- Fishing gears like this have wider ecosystem impact. Science should be robust and not only focus on target species [from NGO representative].

A general point is made by members of the scientific community. Most people present would agree to the five themes that already emerged from the nine responses. But the question is what to investigate specifically? You cannot investigate all. If you investigate effects on plaice then next you find yourself getting questions on turbot. The analogy to a hamster wheel is made. It is felt there should be a conclusive set of questions or some threshold and not turning it to a goal of keeping the scientist in business. To these comments Michel Kaiser responds by saying that this is the point of doing this stakeholder exercise. What needs to be addressed is the question regarding which gaps have the biggest outcome if they are filled.

An NGO representative points out a consultation on concerns and research questions has been held prior to the start of the research programme, amongst others during the 2015 stakeholder meeting. The problem is that there is a clear lack of trust so people will be finding faults with the programme even if it includes research on concerns that were raised. This question has to be addressed. Otherwise people will not want to believe the results. Michel Kaiser expresses the wish that this process will help to re-establishing trust. He wants to make clear that the current programme is

already addressing many concerns and questions. But it is important that problems that are not addressed are looked into and see how they could be addressed within the financial and physical limits. A key issue is also about how the science is being reported. It should not only be done in scientific papers but also be targeted to non-scientific stakeholders.

Michel Kaiser ends the closed session by emphasizing the importance of responding to the survey. ISAC needs a representative number of respondents to make stakeholder input into the programme work.

2.2 Breakout sessions

Four parallel breakout sessions are held. Each session is organised two times: one before lunch and one after lunch. In this way, participants can attend two different sessions.

2.2.1 Into the working of pulse fishing – transition beam/pulse and scale models

The objective of this session is to provide the context of the development of the pulse fishery and provide the stakeholders with information on the technical workings of the pulse gear. Pim Visser of VisNed, the Dutch umbrella organisation for producers' organisations, opens the session with a presentation (see Annex 2) explaining the development of the Dutch fisheries from a historical perspective and shows why the Dutch fleet is as it is today. The Dutch have a tradition of working together as well as innovation. The Netherlands as a country would simply not exist without innovation. His introduction is followed by a presentation by Harmen Klein Wolthuis, manufacturer of one of the pulse gears, on how the technology behind the flatfish pulse works and the benefits and drawbacks of the sole pulse gear (see Annex 3). His explanations are two fold, 'scientifically proven' and based on 'logical thinking'. These approaches both overlap and enhance each other.

Morning session

The first question in the morning session is about the differences in fuel use and catch compared to the traditional beam trawl gear and if the catch rates differ per species. Harmen Klein Wolthuis explains that the catch rates do differ per species. Compared to the traditional beam trawl gear the catch of sole is equal or better and the catch for plaice is less. The pulse invokes a cramp response in flatfish, due to contraction of the body muscles. Sole has a more pronounced reaction to pulse as it is a more muscular fish; its body bends in a U-shape, making it easier to catch it in the net. This effect is less pronounced in plaice. After the transition from traditional beam trawl gear to the pulse gear, the fuel usage of an individual vessel was reduced by half. When fishing with the traditional beam trawl with tickler chains a certain speed had to be kept to keep the tickler chains above the seabed; the pulse trawl allows for a lower fishing speed, due to the absence of tickler chains. The gear is also much lighter. As a result, fuel use and CO₂-emissions are reduced.

A fisherman in the audience asks if a higher voltage is needed for plaice. Harmen Klein Wolthuis explains that plaice is not as bendable as sole. A higher voltage will not invoke a more pronounced U-shape in plaice. He adds that catching plaice at present is inevitable, even when switching off the pulse plaice will be caught, whereas hardly any sole will be caught.

On request of an NGO representative, Harmen Klein Wolthuis elaborates on the effects of pulse on discards and on which species of discards. Based on scientific research the pulse gear reduces discards by approximately 35%, compared to the traditional beam trawl¹. This concerns fish discards, undersized fish species or species with no value. Due to cleaner nets/catches (no stones or debris) smaller fish have a better chance of escape through the mesh.

A participant from the industry mentions that plaice can be seen as a high bycatch within in the sole fishery. Harmen Klein Wolthuis explains that for sole a smaller mesh size in the trawl is needed to prevent it from escaping. As a result, plaice that (has a morphological different shape) enters the net will not be able to escape. However, due the pulse gear fishermen will catch less plaice, which is a good starting point to reducing the plaice bycatch in the sole fishery.

A NGO representative voices concerns related to the effect of pulse on larger species, such as rays. Their concern is that mostly larger species will be targeted with the pulse gear. Harmen Klein Wolthuis answers that if these larger species are really affected, it is to be expected that pulse fishermen will catch them. A scientist comments that one can ask the same for the traditional beam trawl gear: what happens with larger species if and when they are caught in the traditional gear? Another scientist mentions laboratory research on electro receptive animals, which showed no effect. The NGO representative stresses that one should not only to look at the effects of pulse gear compared to the traditional beam trawl gear, but also to explore alternative/innovative gears other than pulse.

During his presentation, Harmen Klein Wolthuis also reflects on the negative effects of pulse gear, including the occurrence of spinal damage in round fish, like cod and whiting, during certain periods of the year. He mentions that the amount of cod caught by the pulse gear is less, compared to the traditional beam trawl gear. A fisherman asks how the spinal damage is caused. Another member of the fishery industry refers to the ICES advice 2016, which mentions that large cod experience spinal damage, but it is also observed in discard-sized cod².

Dick de Haan from Wageningen Marine Research was involved in various scientific studies on spinal damage in cod in relation to the pulse. Dick briefly describes the lab experiments carried out on the effect of pulse on smaller sized cod. He explains that commercial sized cod (30 - 60 cm) were closely positioned near a pulse conductor and undersized cod (10 -15 cm) were surrounded by a hotspot of a conductor (as the electric field is irregular). The laboratory experiment resulted in no injuries in smaller fish that travelled along an electric gear. It should be taken into account that the fish used in the laboratory experiments were raised in aquaculture conditions, bringing breeding and feed composition effect into the observation, which may differ from the situation in field observations. He also mentions that cod tends to escape approaching gear by diving deeper. However, in case of the pulse gear, this will result in the cod positioning himself even closer to the hotspot of the electric field. Maarten Soetaert from the Belgian research institute ILVO, who has also been involved in these studies concurs there are no observations of damage to smaller cod, which can escape the net. Within the middle size class there is some additional mortality. A representative of the Dutch industry adds that the decrease in cod catches by the pulse gear is also related to the height of the pulse wing - the sumwing that is used is positioned closer to the seafloor than the beam in the conventional beam trawl gear. Another representative of the Dutch industry points out that (spinal) damage to round fish is also a negative effect from an economic perspective due to lower market prices for damaged fish.

¹ Adriaan Rijnsdorp, project leader of the multi-annual pulse research programme, who was leading parallel breakout session 2 and could therefore not attend this particular session, submitted the following commented after the meeting: Van Marlen et al (2014) showed in a comparative fishing experiment with one tickler chain beam trawler and two pulse trawlers that the catch rate of discards (kg/hour) of the pulse trawl was reduced to 33% and that the pulse trawl is more selective in catching marketable sized flatfish. Recent experiments, however, have not been able to support the latter. In a synthesis of all available evidence Rijnsdorp et al (2016) concluded that "It is uncertain whether the pulse trawl has a better size selectivity (reduced bycatch of undersized fish), but all experiments show that the bycatch of benthic invertebrates is substantially reduced".

² "Large cod (34–56 cm) are particularly susceptible to spinal damage while cod of 11–17 cm do not appear to suffer to the same degree or indeed at all (de Haan et al., 2016). Spinal damage was also observed in discard-sized cod (20, 23, 27 cm) caught in a commercial pulse trawl (van Marlen et al., 2014)." (ICES, 2016, Request from France for updated advice on the ecosystem effects of pulse trawl. Copenhagen, 4 February 2016).

Harmen Klein Wolthuis also reflects on the newly developed Dutch legislation concerning the pulse gear. A scientist would like to know what the current power is that is applied in practice. Harmen Klein Wolthuis answers that this is 0,5 – 0,6 kW per meter. This is lower than the 1kW per meter allowed in the legislation. The scientist mentions the lack of standardization and wonders if it is tempting for fishermen to cheat and alter these figures. Harmen Klein Wolthuis explains that the average fisherman will apply the maximum pulse during fishing. However, the maximum voltage is still very low and it is not possible to alter it to exceed the maximum. If this were possible, it would only damage the marketable fish, leading to a negative effect (a lower market price for the fish product).

A scientist asks which technical challenges still exist to optimize the performance of such an electrical system. For example for sole, is the length and shape of the conductor well balanced? Or is improvement possible? Harmen Klein Wolthuis responds that fishermen will always try to increase the effectiveness of the gear/the electronics, with less use of power. Fishermen are able to vary with pulse frequency and pulse width between pre-set minimal and maximal conditions to see what happens to the catches. They are aware of the fact that quality of the fish product is a way to gain higher market prices. This can be improved.

One of the scientists comments that the presentation given by Harmen Klein Wolthuis is only related to the flatfish pulse and not the shrimp pulse. Harmen Klein Wolthuis explains the difference between flatfish pulse and shrimp pulse; with flatfish pulse the muscles in flatfish is targeted using a higher frequency. With shrimp pulse a frequency of 5 Hz is used. Session chair Pim Visser adds that during the present break-out session focusses on the flatfish pulse. The Netherlands decided not to focus too much on brown shrimp pulse gear due to all the knowledge gaps that still have to be taken up. Interest in brown shrimp pulse fishing is taking up. Therefore, a plan will be made for brown shrimp pulse research, but as of yet there are no details.

Pim Visser closes the morning break out session with a last question to the participants present: what information has been missing so far?

A NGO member would like to know which species are affected and to what extent? Pim Visser refers to the website on pulse www.pulsefishing.eu, which at present is still accessible, but is under reconstruction. On this website an overview will be given of the effects of pulse on various species. A scientist requests NGOs to better specify which effects and species they are thinking of or would like to have researched when mentioning effects of pulse. Another scientist comments that results on effects of shrimp pulse have been published at present and show no side effects so far.

Afternoon session

Following up on questions following the morning session, Harmen Klein Wolthuis explains that the effect of the pulse (the amount of volt placed) on fish is determined by fish size, the location within the electrical field and its orientation (perpendicular or parallel to the electrodes). To illustrate, the amount of volt that is placed on a fish in the electrical field can be determined by determining the amount of volt at the head of the fish and at its tail. For example, would this be 30 V on the head and 20 V on the tail – the total amount of volt would comprise 10 V. A member of the French industry inquires how much volt is needed to catch a 24 cm sole considering it is perfectly placed within the electrical field. Harmen Klein Wolthuis responds that to move it you will need at least 5 – 4 V. A scientist adds that the closer the fish is to an electrode the higher the field strength it will encounter. The industry member comments that if such is the case, the gear is not really selective? Harmen Klein Wolthuis explains that it has to be viewed in comparison with the traditional beam trawl gear. By using the pulse gear the smaller fish get less affected than the bigger fish, as a result less smaller fish (discards) will be caught. In addition, the pulse gear has a much cleaner net (less stones and debris), resulting in a better fish quality and smaller fish can escape with less damage due to less debris in the net.

One of the ISAC members would like to know if information is being collected on prices for fish from pulse gear and prices for fish from the beam trawl. Pim Visser responds that the sole that is caught at present is primarily caught by pulse gear, while beam trawl gear focuses on plaice. In addition fish prices can differ a lot between auctions. Therefore it would be necessary to study price developments over several years, but this can be done by doing retrospective research. The ISAC member

recommends comparing prices between pulse and beam trawl gear by also looking at Belgium vessels and prices.

In relation to the spinal damages in cod, Harmen Klein Wolthuis explains that cod catch is limited in the Dutch fleet and of the amount that is caught only a small part undergoes spinal damage. A government representative enquires after the reaction of cod (40-60 cm) on pulse. Pim Visser explains that (spinal) damage in cod have been observed in laboratory experiments and in the net. In practice, this can be seen by a dark mark in the middle of the cod. The government representative then asks how much cod is caught in the sole fishery. Harmen Klein Wolthuis explains that this depends on the period of the year and on the locations fished. Cod caught in the sole fishery in general less than 3% of the catch. Catches take place only during a certain period in the year and only a small amount of this caught cod will have (spinal) damage. Harmen Klein Wolthuis remarks that damage may also occur to whiting. Both fish will still be marketable, however for a lower price as the damaged area will have to be cut out of the filet. A member of the scientific community adds that the vulnerability of cod/whiting might have to do something with the food they get at a certain life stage. Pim Visser adds that this spinal damage raises concerns about animal welfare and the price for the product.

In relation to the development of legislation on pulse gear, a member of the scientific community wonders if it makes any difference in which material is used for the electrodes. And if it would not be wise to give limits on the material that may be used for the electrodes? Another scientist responds that the effect of different materials for the electrodes is minimal compared between the effect of a new electrode and one that has been used for a longer period, in particular the degree of corrosion and damage.

A government representative comments that, if understood correctly, a fisherman has three buttons he can use to experiment with: field strength, frequency and duty cycle, within the ranges indicated and allowed by the legislation. In this case, does each fisherman have his own experience? Harmen Klein Wolthuis indicates that most fishermen will use fixed settings. Experimental fishermen will experiment, however the effects will not be very different.

A representative of the fishing industry notes that a frequency of 60-80 Hz is deemed effective. Yet, within the new legislation a frequency from up to 180 Hz is allowed. The reason for this is not clear. Harmen Klein Wolthuis explains that research showed that a frequency up to 100 Hz is too much for a good catch. However, increasing the frequency above 100 Hz could have a positive effect on the reduction of spinal damage. As a result, room is left within in the new legislation concerning the frequency to see how this can be used.

A government representative is interested if there are any other species that do not react to pulse as well, like plaice. Harmen Klein Wolthuis replies that sole is often compared to a cat (flexible, vast and intelligent), being able to escape easily. In traditional gear, heavy tickler chains and a small mesh size are necessary to catch sole. However, due to its response pulse is the sole's weakness. Plaice is less flexible, so the effect of pulse on plaice is limited. Harmen Klein Wolthuis suspects that muscular fish may be affected more by pulse.

In response to the question 'what about shrimp?', Harmen Klein Wolthuis responds that for shrimp it is sufficient to use the frequency that shrimp uses in its natural swimming behaviour, 5 Hz to get the shrimp to come off the seabed. When using a frequency below 20 Hz the muscle behaviour of the shrimp is stimulated and there is enough time for the shrimp to relax its muscles.

One of the ISAC members questions if any research has been done on the response of elasmobranchs. Another scientist replies that this has indeed been the case, and research has been done by ILVO and Wageningen Marine Research. Laboratory experiments show no difference in feeding behaviour after exposure to pulse. He is uncertain if the elasmobranchs showed signs of cramp as a result of pulse exposure.

A scientist notes that the electrodes used in the pulse gear are robust, thick and heavy. Do they have to be so heavily wired? They have no function concerning the tension of the gear. The reply by both Harmen Klein Wolthuis and a scientist from the audience is that the electrodes need to be sturdy for when they hit the sea floor and against abrasive strength. Changing the robustness/heaviness of the electrodes will have no large effect on discards or such. A certain amount of weight is necessary to have the electrodes next to the seafloor. A follow-up question is if the electrodes can be placed right at the beam? Harmen replies that the new legislation prevents this. The pre-runner should be at least 3 meter from the isolated parts.

A representative of the fishing industry inquires if we know what happens to the fish that are affected but not caught. Harmen Klein Wolthuis answers that when comparing the pulse gear with the traditional beam trawl, fish that can escape from the beam trawl will probably suffer more damage than within a pulse net due to the greater amount of debris in beam trawl nets. Pulse gear catch show fish to be more lively.

The ISAC member mentions the accusations heard in the United Kingdom of pulse burning fish. It would be good to gather evidence concerning these allegations to see to what extent this is true. Pim Visser responds that research into these accusations on the eastern part of the North Sea have been carried out in Belgium approximately three years ago. These tests were not conclusive. A scientist mentioned that in laboratory tests in Belgium showed no burns on fish. Over the last 24 months no damaged fish, wounds or ulcers have been reported on the eastern part of the North Sea.

2.2.2 Break out session 2: Setting the scene – research in hindsight and forecast

In this session, Adriaan Rijnsdorp of Wageningen Marine Research provides an overview of the past, present and future research on the ecological effects of the pulse gear technique (see Annex 5). The underlying question of this session is what do we need to know before we can answer the question if the replacement of mechanical stimulation (beam trawl) by electrical stimulation (pulse trawl) can reduce the ecosystem effects of fishing and improve selectivity? The rationale behind the research agenda is to develop a mechanistic understanding of how electrical stimuli affect marine organisms and their ecological functioning. When we understand how a pulse stimulus works and why it has certain effects, then we can explain the effects observed in the field.

Morning session

A Dutch fishing industry representative notices that in the last couple of years, the NGOs raised a lot of questions about the effects of pulse fisheries, but now they are not present in this session that addresses these questions.

A fishing industry representative reflects on the presentation. He notices that it seems as if the results in terms of bycatch species do not appear to be different for every category and effort. He also wonders whether effort is reduced in terms of footprint. Finally he notices that catch efficiency for smaller sizes seems to be different compared to the conventional gear; if electricity works better to catch larger fish this might be interesting, but it is not proven yet. How this phenomenon and its impact relates to the larger population is an interesting question. In response, Adriaan Rijnsdorp replies that comparative fishing is not part of the research.

Another question from the audience is related to the way the experiments are carried out: are the same pulse characteristics used in the laboratory experiment as the industry uses? Adriaan Rijnsdorp comments that the pulse parameters studied will be broader than the current settings, so we can infer the consequences if settings may change.

A fishing industry representative asks if in the field experiments a comparison will be made between fished and non-fished areas (and not only a comparison between beam and pulse). Adriaan Rijnsdorp replies that three research cruises are planned: one of them is in an area closed for fisheries (part of the 'Vlakte van de Raan' area) to compare the effects in this area to that of an area outside the non-fished area.

A Dutch representative from the small-scale fisheries representative shares stories he has heard from colleagues: they usually notice only a small amount of small dead fish in the wake of a conventional beam trawl, but a large amount in the wake of a pulse trawl. Based on these stories, he would like to see a field experiment with a conventional beam trawl and pulse and compare the effects of both techniques. Adriaan Rijnsdorp replies that this could be an interesting idea to follow-up. Currently, such a field experiment is not part of the research plan. Theoretically, the use of tickler chains might attract larger fish that prey on smaller fish that are attracted to the disturbed sea bottom.

The same small-scale fisheries representative has also heard stories about the disappearance of larger fish in areas where pulse fishing takes place: could it be that the impact of pulse on larger fish is stronger than on smaller fish? Another question is if fish get used to the pulse gear, so that eventually more pulse would be needed to stimulate the fish? Adriaan Rijnsdorp explains that as part of work package 1, the response of fish to low stimuli will be studied. Examples of research questions are: are fish able to sense a pulse stimulus outside the width of the gear and move away? Are they able to adapt to pulse?

In response to a question from one of the scientists, Adriaan Rijnsdorp explains that in the sea fish will be exposed for a very short period only. Based on VMS data we can infer that multiple exposures over a short time period will be highly unlikely.

An NGO representative asks about the field trials in closed areas: how long have these areas been closed and what habitats are being assessed? Adriaan Rijnsdorp comments that this area was selected because it is already closed for a couple of years; it will be closed for three more years before it is being assessed.

A scientist notices that it seems that animal welfare issues have so far not been taken into account in the research agenda. Adriaan Rijnsdorp confirms that welfare is not included in the research on pulse. Martin Lankheet from the Department of Experimental Zoology of Wageningen University, who is involved in work package 1, adds that it is quite difficult to specifically study welfare but that the behavioural responses to pulse stimuli can be used as a proxy.

A representative from the processing industry wonders if the behaviour of pulse vessels is different than conventional beam trawlers: would they have a different pattern or behaviour than conventional beam trawlers? Does the behaviour of fishermen change? A Dutch fisheries representative responds that fishing vessels that changed their gear from tickler chains to pulse are now also fishing in different areas than before (although the overall fishing effort decreased in that period as well). But the behaviour is the same: they may stay in an area for 12 hours or 3-4 days.

A representative from the policy field mentions that the European technical measures regulations stipulate that if new gears are introduced, there should be scientific evidence that they are better than the ones they are replacing. In the case of the pulse gear, ultimately there will never be a final answer in terms of all the knowledge questions that could potentially be looked into. This is why decisions are needed about when enough research has taken place to make a decision.

A scientist asks whether it is possible to adapt the field strength to improve the selectivity. Adriaan Rijnsdorp answers that the current pulse gears have been developed to catch as much of the target species as possible. They have not been designed to catch a minimal amount of bycatch (smaller fish). There is a general feeling that larger fish are much more affected by larger field strength than smaller fish, so you could potentially develop a size selective gear. So far, this has not been tested in practice. This is why we will look into the effects of certain pulse parameters to, for example, improvements in size selectivity.

Maarten Soetaert from ILVO who has been strongly involved in field strength experiments comments that if the field strength would be increased, there would be an area between the electrodes where the field strength is insufficient to cause a cramp response in sole, which is required to catch the sole. To compensate for lower field strength, it is theoretically possible to use more electrodes. However, this would make the gear heavier and would result in more impact on the seafloor.

A representative from the processing and trade industry wonders if there is an effect of pulse on the fish that escapes through the net; in what way would it be affected by the pulse? Adriaan Rijnsdorp answers that this is an important question. If we know how fish size affects the response, we will be able to predict what will happen to the smaller size classes escaping through the meshes.

A NGO representative asks about the biochemical effects of pulse: how does it affect the chemical composition of the water? Adriaan Rijnsdorp replies that this aspect is part of the research that will be taking place. As the electricity used is bipolar, the chemical effects will most likely be less though.

A fisheries representative asks what the maximum number of licenses is. Adriaan Rijnsdorp replies that in The Netherlands, it is currently 84, but they will expire in 2019. In other countries it is also possible to use the pulse gear: under derogation from the EU a certain percentage (5%) of total effort could be used for pulse fishing.

A Dutch fisheries representative asks what the effect of the gear itself would be in comparison to the effect of the pulse electrodes. What if you would switch the electrodes off and see what happens? (i.e. left side switched on, right side switched off). Adriaan Rijnsdorp responds that there is a slight effect of pulse on how fish escapes the net. Larger soles are able to escape more easily from a conventional beam gear than from a pulse gear, where it is constantly stimulated.

An NGO representative mentions the MSC certification process, where the independent certifying body decided not to certify the pulse fisheries due to a lack of knowledge about the effects, including the long term effects. The question is if the scientific team involved in the research programme is aware of this report. The recommendation to the team is to read this report and ensure the questions raised in this report are addressed as MSC is after all seen as the standard for sustainable and well-managed fisheries. Nathalie Steins of Wageningen Marine Research responds that the MSC assessment report is in the public domain, and affirms that the research team will check if the issues raised in it are being addressed in the current research.

In relation to the previous question, a Dutch fisheries representative involved in the MSC assessment points out that the certifying body provides a list of questions that need to be addressed. However, it seems that more questions are asked for this the pulse fishery than any other type of fisheries, for which the same kind of questions are not being addressed.

Adriaan Rijnsdorp responds that any long term effects will be based on what we know about the short term effects and then how they could potentially accumulate. In this sense, knowledge is limited so we have to be realistic on what science can offer in terms of answers.

2.2.3 Control & Enforcement – lessons learnt and developments

Two sessions were held on the subject of control and enforcement. During the morning session Richard van Buuren of the Netherlands Food and Consumer Product Safety Authority, assisted by his colleague Lennert Schrader, started with a presentation on the development of the control and enforcement of pulse fisheries (see Annex 6). He explained how they had to discuss with policy makers, researchers and the manufacturers to develop requirements to the pulse technique that can be controlled. He explained how a process of standardization makes it possible to capture the dynamic developments and innovation of the pulse technique in flexible agreements between industry, ministry, enforcement authorities and manufacturers. This allows for more flexibility than static legislation. In addition certification of those units of the pulse technique that cannot be controlled forms an important element of the control and enforcement of the pulse technique.

After the presentation the audience was asked to write answers on sticky notes in reply to questions in figure 2.

During the second session, after the lunch, the order was changed. First the audience was asked to reflect on the questions and consequently Richard van Buuren held his presentation. In general, the second session was more lively, more critical questions were asked.



6 Flap overs; give your opinion about....

1. What do you deem appropriate sanctions in case of non compliance?
2. How would you stimulate self-control by the pulse fleet?
3. I deem control of the requirements easy/difficult.
4. I would organize control as follows:
5. What innovative control tools would you suggest?
6. Certification (and normalisation) is the way forward in (pulse) fisheries control.

18

Figure 2: Questions to participants in break out session 3

Morning session

After the presentation, the floor was opened for questions.

A fisheries manager asks whether it is technically possible to set up the installation on board in such a way that the electricity cannot be exceeded above a certain limit. Richard Van Buuren replies that this has been done; the 60V peak limit between the electrodes cannot be exceeded.

A scientist asks what assurances there are that the gear cannot be modified after it has been certified. Richard van Buuren replies that it is impossible to rely for 100% on standardisation and certification, but that the inspectors on board check the equipment to be sure that no seals are broken. In addition, inspectors are trained to extract data from the data logger and to inspect the ship.

A staff member of a politician asks in what way this control and enforcement method is shared with other control agencies. Richard van Buuren replies that the Netherlands Food and Consumer Product Safety Authority works in a 100% transparent way. However, contrary to enforcement in the non-food area where control agencies cooperate very closely, in the food area the landscape of control and enforcement is scattered. Hence, the cooperation between European Member States is not as good as the Dutch authorities would like to see it.

An industry representative points out that his members observe pulse vessels fishing above 55 degrees North. How does enforcement deal with this? Van Buuren replies that this is being monitored and an investigation is going on. An update can be provided in 1-2 months. A Dutch industry representative comments that for some pulse vessels it is legal to fish with pulse above 55 north latitude. The other industry representative comments that when his members contact the pulse vessels observed above 55 north latitude, they reply that they have their pulse turned off. He asks whether it is possible to fish with the electricity turned off.

A representative from the policy field asks about the advantage is of standardization over legislation, when standardization is also intended to hold for the long term. A representative of the standardization authority answers that every standard is reviewed at least every five years, which makes it more flexible. In addition, all the information about a standard is publically available. The staff member of the politician asks whether there is an incentive at all for fishermen to manipulate the pulse gear and whether the control agencies do a risk assessment. Richard van Buuren replies that their enforcement policy is 100% risk based. Vessels are categorized in the red, orange or green category, depending on their track record of violations of the rules. Vessels that have manipulated the rules more often, are investigated more frequently.

A scientist asks to what extent the enforcement policy distinguishes between different pulse fishing techniques, such as flatfish, shrimps and ensis (razor clams). Richard van Buuren responds that in the risk assessment no difference is being made. The scientist clarifies his question: do the same requirements apply to flatfish pulse fisheries and other pulse gear types? Richard van Buuren answers that they do not, i.e., the discussed requirements are for pulse fishing on flatfish.

A representative from the policy field asks how the inspectors can be sure that manufacturers do not manipulate the gear according to the wishes of their customers. Richard van Buuren answers that inspectors inspect the ship, they copy the data of the data logger on a USB stick. If they cannot see data on the last 40 trips, they know the software has been manipulated. There may be soft spots still that are currently unknown.

An NGO-representative poses two questions: would it be possible to set up the system so that when the electricity is increased above a certain level, it is turned off automatically and that immediately a sanction is issued? And secondly, with regards to the risk assessment, does this mean that the ones that are smartest get away with offences? Richard van Buuren agrees that this is a risk. Lennert Schrader adds that in one of the two pulse gears on the market, the electricity cannot be increased above 60 V.

One of the ISAC members comments that the pulse gear has been developed to increase catch efficiency and to reduce energy consumption, but that the decrease of effects on the ecosystem is only in the beginning. Hence, he argues that it is good to have standardisation but that technological development should not be hampered. Another scientist asks how long it takes to change a standard. The representative of the standardisation authority replies that standardisation is not only on how the gear should look, but also on standardising the language and the requirements of the technique. When it needs a change it depends on the stakeholders how long this takes. When they all agree, it goes fast. When a revolutionary change is required, it is more sensible to start a new process to replace the old standard, this takes more time.

A Dutch industry representative comments that in the end the maximum volt that is used in the gear has decreased a lot since the pulse experiments started. If you bring the volt up, this decreases the catch. In addition he argues that the catch is more lively than the catch caught with the beam trawl. He is confident that the scientific investigation of the pulse gear will provide evidence that it is a gear with less impact.

At the end the participants wrote their thoughts on sticky notes. There are two points on which a lot of agreement can be found in the comments: (1) many participants regarded suspension of the pulse licence an appropriate sanction in case of violation of the pulse requirements; and (2) a black box would be a good instrument to control the use of the gear.

Afternoon session

This session started with the audience answering the questions on sticky notes. During this second session, more questions were asked compared to the first session, where Richard van Buuren first gave its presentation before questions were allowed.

When Richard van Buuren showed the document with the pulse requirements a scientist asks whether this only applies to the Dutch pulse fishers. Richard van Buuren confirms that it does. Another scientist remarks that he is happy that the document has not changed since the last few months.

When Richard van Buuren explains that 60V is the maximum peak voltage, a fisherman asks whether this applies to a measurement in the air or in the water. Lennert Schrader replies that it applies to air under lab conditions.

A fishing industry representative remarks that inspectors cannot measure every single aspect of a technique, but that for some aspects a manufacturer's warrantee is required. This makes enforcement easier. Richard van Buuren confirms this and says that this is exactly what they did. He explains how the data of the technique of the last 100 trips are recorded and checked by the inspectors, when another ISAC members taking part in the session remarks: 'you know Volkswagen'. This ISAC member continues to say that fishermen are smart and that making rules on fishing technique is an arms race.

Richard van Buuren replies that his is a different situation in which they deal with two manufacturers, which makes it easier.

A fishing industry representative comments that he heard that increasing the voltage does not increase the catch. Hence, enforcement should be combined with a course for fishermen on how to use the pulse gear. Richard van Buuren replies that it is not necessary, as the output of the gear cannot exceed a maximum peak voltage of 60V. The industry representative argues that it needs to be explained to fishermen, as they might otherwise electrocute themselves.

A scientist argues that standardization of electrodes is useful as with pulse gear you cannot see the strength of the output. However, it would be good for research if the data logger would register exactly the voltage that is being used, in order to know the exact voltage fishing areas are exposed to. 60V is a limit, possible lower voltages are being used. Richard van Buuren replies that the data can be given to the research institutions.

A scientist requests a copy of the pulse requirements. Richard van Buuren replies that it will be attached to the meeting report (see Annex 8). When he explains that the number of pulse licences is restricted, the same scientist comments that this is a funny remark as the Dutch managed to get a lot more licences than the other member states. Richard van Buuren replies that he expects that in 5-10 years the use of pulse will be widespread. The scientist replies that he hopes so, although under certain conditions.

Richard van Buuren states that in his opinion control and enforcement is easy. This is contrary to the expectations of the audience. Most of the participants wrote on their sticky notes that they expect it to be difficult. A scientist remarks that he is not sure that it is easy. First, if the parameters are set so high, no one will reach the limit, it is easy. But the technology is complex. Secondly, he points out that while he likes the innovative approach of the Dutch, the problem is that they followed their own way. Discussions about pulse should be held at the European level. In addition, he agrees with the point made in the NGO presentation during the morning plenary that the focus on pulse is too narrow minded and that other alternative technologies should be taken into account as well. A Dutch industry representative responds that they cannot talk to everyone and that the control and enforcement of pulse has been discussed in the North Sea Advisory Council (NSAC). Another Dutch industry representative remarks that pulse has been discussed a lot in ICES, for example in WGELECTRA.

In response to the comments of the Dutch fisheries representatives, an NGO-representative remarks that little on control and enforcement was discussed in the NSAC. The NGO representative asks to what extent this information about control and enforcement is shared with decision makers at the European Commission level and whether it is static or an ongoing process. Richard van Buuren replies that it is an ongoing process and that now enforcement can really start. The NGO representative then asks to what extent he is confident about the risk based approach as it seems random to her. Richard van Buuren replies that the risk based approach does not only refer to the pulse requirements but to all the rules fishermen have to comply with.

An industry representative asks whether the presenters are aware of the requirements for pulse vessels of other Member States. The answer is that they do not. The same industry representative argues that he is not sure if 'normalisation' is the way to go with pulse. Richard van Buuren replies that this is the same as standardisation, which has a different meaning to the industry representative.

The last question comes from a certification standards holder, he asks whether it is easier to control pulse gear than conventional gears. Richard van Buuren answers that it definitely is easier to control the pulse gears.

2.2.4 Elaboration – Scope and regionalisation within EU – broader scope

Kees Verbogt of the Dutch Ministry of Economic Affairs kicks off the session with a presentation on the policy process so far, its context and some questions on how regionalisation can assist innovations in the fishing industry (see Annex 7). The objective of this break out session is to get a feeling of the views of the different stakeholders on these questions. He leads the session together with his colleague Evelien Ranshuysen.

Morning session

One of the NGO representatives explains how their organisation has been assessing the innovative gear provision of the new European technical measures proposal and comparing that with the process the innovation of pulse took. Currently the proposal describes that a new gear should show that the impact is reduced including robust evidence. It is important that there is independent evidence and not just a Member State stating it. It would be questionable that the pulse would have come so far with the new technical measures proposal. Furthermore this representative is interested to know how far the Netherlands are with control and enforcement and how other Member States can obtain the technical information.

Kees Verbogt responds by adding to his presentation that the pulse pilot project will run until 2019. Then the Dutch government will ask the Scientific, Technical and Economic Committee for Fisheries (STECF) to review the innovation and on the basis of the outcome a decision will be made on whether or not to continue. If the outcome is 'no', the Netherlands will stop. If STECF says that, for example in combination with good control and enforcement, pulse fishing is okay, the Dutch government feels the ban should be lifted. Until then the Dutch government will not expand the number of licenses. The same NGO representative responds by saying that that is promising; an independent assessment of STECF. The representatives agree with the analysis on how the process went. From a legal perspective, the extension of licenses to more than 5% remains an issue.

One of the ISAC members cautions Kees Verbogt not to say that the outcome of the advice of the STECF would be a 'yes' or 'no'. Perhaps STECF will say that the wrong questions were asked. The ISAC member suspects that if that would happen either not *all* questions have been asked or the set-up of the experimental fishery is not good enough. An example is that no areas are demarcated only for pulse and others for traditional beam trawls, which poses a challenge in answering ecosystem questions. Now the pulse fishery is so spread out over different locations, that it is difficult to study ecosystem effects. The ISAC member flags this as a warning: pull away from 'yes or no', in other words: do not do Brexit. The Dutch have set on a journey, it is difficult to change, there is a short scientific program; it might still be needed to ask other questions. Do not to throw away a useful approach to fisheries simply because of that.

Evelien Ranshuysen clarifies that if STECF says for example 'pulse may be an alternative to the beam trawl, but there still is a knowledge gap', the Dutch government will consider this a go. Kees Verbogt continues by pointing out that we cannot go on with a pilot forever. STECF perhaps might see a clear no. By 'no', Kees Verbogt means a situation where there are clear and significant impacts that cannot be mitigated.

Another representative of a NGO shares that there was an outcome of the pulse MSC certification assessment. This NGO representative advises the government to read that document and to use it as a benchmark. Evelien says this is a good suggestion. She added that she read the assessment as a fairly positive document ('we are getting there') and that the fact that the pulse is not permitted is a big issue for the certification. The NGO representative comments that a score of 65 on Endangered, Protected and Threatened (ETP) species is really low. And that the impacts on ETP species is not addressed in the research programme.

The first NGO representative continues by asking how many vessels currently are involved in doing research, as last time it was a small percentage. Kees Verbogt replies that currently monitoring takes place with all fishers (73).

In response, a fishing industry representative asks if 73 vessels participating can really be called a pilot project. This fishing industry representative wants clarification if the Dutch ministry will really make 73 fishermen stop if STECF is of the opinion that pulse is not sustainable and innovative. What will they do? Kees Verbogt responds that these fishermen will then go back to beam trawling, which is the only alternative for catching sole. This decision will depend on various factors, for instance the fuel price. A Dutch pulse fisher confirms that now that the price of fuel is low and the price for plaice is high (doubled, it is economically possible to revert to the beam trawl).

The same fishing industry representative asks why the project had started now, and not earlier. Kees Verbogt explains that the research programme started in 2014. Before that various research projects already took place; it is not starting from scratch. But the pilot project in the current form started in 2014.

Evelien adds that the research started when there were 22 permits. There were multiple projects on short term and direct impacts. This big project is targeted at examining the long term impacts. One of the NGOs questions if Dutch are not throwing all their eggs in one basket. Or are the Dutch looking at alternatives if the pulse is not allowed? The negative impact of the beam trawl is well-known. Are the Dutch looking at alternatives? Kees Verbogt explains that other gears have been developed as alternative to the beam trawl, such as twinrig and flyshoot. But for catching sole, the pulse trawl is currently the only alternative. It is hard to come up with more innovations. Most of the resources go to dealing with the landing obligation, next to the pulse. Then the Dutch government is also funding work on net innovations for catching nephrops. Pulse fishing is a substantial change. The other things that can be done is tweaking nets, but that is not as substantial as removing all tickler chains and replacing them with electrodes. Fishermen are now looking at 'removing the cod end' and such fish out of the net via a water tube. Now the fish is in the net for 2 or 4 hours. If you manage to get the catch on board immediately, via a tube, it can also go back quicker resulting in a higher survival rate. This was tested in the shrimp fishery, so ideas to use such a system are also there, but for now this is really premature.

The industry representative who spoke earlier expresses the hope that the new technical measures regulations will be adopted before 2019. Also this representative raises the question what will happen if in the new technical measures regulations the pulse fishery is legalised and STECF says no. Kees Verbogt responds by stating that the regulations says that an STECF assessment is needed. The industry representative responds that it could help the pulse fishers if the pulse is mentioned in the new technical measures regulations.

Evelien explains that although now the pulse is a topic of discussion as part of the new technical measures regulation, it is important to discuss innovation itself. All future innovations will need to be handled within the European system, and there is an urgent need for general guidelines as without them it will be difficult to innovate.

The NGO representative who opened the discussion stresses that from a legal perspective, it feels wrong to single out pulse in article 24 of the technical measures regulations; it should just be about innovative gears. Kees Verbogt explains that singling out pulse was what was done in the first proposal. Allowing pulse through the new technical measures regulations would of course be for the Netherlands. But looking at the situation now, it is actually better that the procedure for allowing innovative gears in general is clear. In response the NGO representative adds that the procedure is one thing, but that the standards need to be defined from the start.

The ISAC member stresses the importance of having a good process. Regulations can have stupid limitations. For example, fishers would like to use larger meshes but there are limitations on the size of meshes impeding fishers from being innovative. Discussions on light use innovation are also ongoing. Maybe light innovations will turn out better than pulse in its current form at some point. This means we need to have a process for innovations in general.

The same NGO representative continues that at the moment it is not clear. The current text of the technical measures does not involve all possible impacts. For instance impact on species not in the catch is not included. This implies that one would have to prove it does do harm, but it should be the

other way round. The ISAC member acknowledges this but is worried that it becomes unbalanced as there are not yet any of such criteria defined for current gears.

Another NGO representative continues on a point raised earlier and asks how it is even possible for an NGO or any other stakeholder to prove that a gear does harm in view of the high costs that would involve. The ISAC member suggests an approach where you infer what happens – with large areas with only pulse. A colleague NGO raises the question: “if the burden of proof is on me? How to do it?” The NGO representative adds that a precautionary approach is required.

The industry representative who spoke earlier says that while (s)he is not pro-pulse, (s)he is speaking for fishermen in pointing out that if fishers need to prove a gear before they start, they can never start. This is acknowledged by the NGO representative, who then clarifies that proving that the gear is better is the suggestion.

The industry representative continues to say that in the pulse fisheries mistakes were made in the beginning: the voltage was too high, fishers from the North of France found red blisters on their fish but now they not see them anymore. So maybe there are improvements.

Kees Verbogt responds by saying that there is no scientific proof for any relation between blisters on fish and pulse fishing. It is an interesting example. The Netherlands heard about these allegations and then researchers took dab, exposed it to pulse and no blisters occurred. These experiments were carried out in Belgium and in the Netherlands. But is that proof enough? In the end, it is hard to prove such a thing. He rarely hears about blisters anymore these days.

The ISAC member points out that we want fishers to engage in innovation. The current legislation does not help. Fishers need to understand what is needed. What could be done is to define agreed protocols for testing innovative gear; develop a methodology: area, replication, ETP species, etc. He suggest that STECF could perhaps be asked to put it all together as a manual.

A Dutch pulse fisher says that in his opinion fishers always innovate in whatever fishery they are engaged in. Most of it is legal, but the pulse is banned. With other gears we were able to make changes along the way. The flyshoot and twinrig fisheries changed and can go on. But with the pulse it is difficult. Some say there are too many licences for pulse. In the opinion of this Dutch pulse fisherman it would have been better to have a smaller amount of licences and spend more on research; now it seems to be out of balance.

One of the NGO representatives finds this a really good point. The baseline of pulse is that it was an illegal gear and there were reasons for that. This means the development of this gear is measured against a higher standard. It is no secret that maybe it could have been different. There has been political pressure. If this can be resisted in the future, it will be better. Kees Verbogt responds that in the short term, the increase in number of licences was a victory, but on the longer term the Netherlands and other countries who are interested in the technique might have shot themselves in the foot. At the moment, there is interest in developing a pulse gear for the brown shrimp fishery. Five fishers are involved. It is key to keep it small and do research and learn from the mistakes we made previously.

From the NGO community the question is raised whether the shrimp pulse differs in parameters. Kees Verbogt answers that in the requirements for control and enforcement a distinction was made between the flatfish and shrimp pulse. The NGO representative is interested in learning more about the difference. The Dutch pulse fisher says that is not possible to catch shrimp with a flatfish pulse trawl and vice versa.

The ISAC member considers the costs of research into these innovations to be a problem. What should not happen is that other innovations are killed because of this. Kees Verbogt acknowledges this and says that available resources can only be used once. The NGO representative suggests that there should be a better system in place for Member States to share information. Evelien Ranshuysen says that this should be included in the protocol; innovation as a coproduction of Member States.

Kees Verbogt says that the point is that the Netherlands hold a large part of the sole quota. In that respect it makes sense for us to focus on pulse as an alternative to the beam trawl. The ISAC members comments that while there are UK registered pulse vessels, these are all Dutch companies. The industry representative says that the Dutch are always first to propose something.

Evelien Ranshuysen points out another challenge. The rules of the European Maritime and Fisheries Fund (EMFF) are very tight now which makes it difficult to fund innovations. The Dutch pulse fisher says that it is not always the money that is a problem. In the last years, the fleet made a good profit. This means that a fisherman has to invest now. A few years ago we needed money from the EU. And there is now a problem with paying back some of those subsidies. The big problem for the fishermen now is the one of legality of the pulse trawl.

The representative from the fishing industry who spoke earlier wants to know why there are now 73 licences in use when 854 were issued. Kees Verbogt replies that the sole fleet was doing bad economically. Initially, 42 licenses which were also in use; but there were also 40 more fishermen who were interested in the technique because of cost reduction. Therefore, there was a lot of political pressure to allow all sole fishers to fish. The Dutch government managed to do this under a derogation of article 43 of the technical measures regulations which offers room for a combination of research and licenses. Also article 14 was used.

In response to a question from an NGO representative Kees Verbogt says that most of the beam trawlers targeting sole are using pulse; there are about 6 that still use the beam trawl with tickler chains. Then there are fishermen with large plaice quota and small sole quota who have changed to twinrigging; some may still use beam-trawling. The majority of the fishermen targeting shrimp are still using the shrimp beam trawl, except for the small group of 5 who are experimenting with pulse. About 120 beam trawlers target flatfish (sole and/or plaice) and 300 target shrimp. From that group of more than 400 beam trawlers around 73 are using pulse.

The ISAC member asks if the Belgian fleet is also using pulse. Kees Verbogt answers that the Belgians mostly fish in the Irish sea, where the pulse is not allowed (yet).

Afternoon session

In response to a comment made by Kees Verbogt on the timing of the research, a representative from the policy field and former scientist who has been involved in the pulse trajectory for a long time points out that the ICES working group on fish behaviour was the first group to look into the pulse. A big problem was the lack of transparency at that time, which was mainly related to the mechanics of the pulse system itself. If something new comes on table, for instance the snapping of spines, it is important to know the pulse limits. The problem at the time was that the pulse was a commercial innovation and the manufacturer simply did not want to disclose the mechanics of the system. This is a valid perspective for business but from an evaluation point of view, it did not help. Research was done as early as 1990s and early 2000, but this was one of the critical things science needed to know but could not get a hold off. This generated scepticism. A scientist confirms that in Belgium already in 1996 preliminary exposure tests were carried out with a range of animals. No mortality was found as a result of pulse exposure, so the next step was taken. All experiments at sea were also conducted as experiments in the lab. Other universities were involved. By the time the commercial fishing started, Belgium had three PhD students looking into the effects on pulse. The research was good, but indeed openness and transparency were lacking. Kees Verbogt acknowledges these early research projects and clarifies that in an ideal situation, the multi-annual research programme that is being carried out right now should perhaps have started earlier. The same goes for more stakeholder involvement. He understands that research takes long and takes a lot of resources. Now there momentum to do carry out the long term impact research assessment and get the input from stakeholders as well.

Another scientist points out that research on seafloor disturbance started in 1992. This year the BENTHIS project ends. In total this is 26 years of research which makes it possible to can draw some kind of conclusion. So research takes time. It should go in equal pace with the innovation, and this did not happen here. The commercial use expanded very quickly and that caused anger.

A fisheries representative poses the question how unique the pulse is. Innovation may also entail modifications. There is no difference in legislation yet. There is research being done on benthic impact for other gears, as there ecosystem concerns related to other gears as well. We need to separate the two. As industry representative, he wants to have understanding of the impacts of different gears. Everybody knows improvements of gear selectivity has been hindered by the current technical measures regulation. What is needed is a tree of options in innovation.

Kees Verbogt agrees that the pulse is a special case; this gear is technically forbidden. This differs from innovation within the boundaries of the law.

A member from the scientific community adds that the use of electricity is a potential public concern; it is perceived negatively. It is best to try to find out from the start about the concerns. Kees Verbogt response by saying that the group of stakeholders consulted in the beginning was very small. An NGO representative confirms that the Netherlands have a stakeholder consultation model. Stakeholders are generally represented well. In case of the pulse, the stakeholder consultation was perhaps too fragmented and this may have caused the problem.

Kees Verbogt remarks that in the Netherlands, there is little public debate about the pulse. There is a general lack of knowledge among the general public about fishing techniques. That may be one of the reasons: people do not know how fishermen fish. Most fish caught in the North Sea is also not eaten by Dutch consumers, but is exported. There is a weak link between society and the fishery. In general the perception about the fishing industry is positive (hard working fishermen, vessels in harbours, culture). NGO representative points out that consumers have never invited to the discussion.

A representative from the policy field believes that for consumers price is the most important. If people think pulse is okay, this is probably because there is a lot of negative writing on the beam trawl. It is important not to look at pulse in isolation from the beam trawl – it is replacing the beam trawl. This comparison is of particular importance.

Kees Verbogt says that people in favour of the pulse trawl indeed make that connection. People that see pulse separately are concerned about the effects. One of the scientists points out that his was also the case for chicken laying eggs in battery cages. It replaced something that was worse, but no one will advocate cages on the basis of that. NGOs can mobilise the general public quickly.

An NGO representative says that their organisation has always supported the pulse because it was thought it was a great alternative; yet, it should be looked at separately. For example, in relation to Natura 2000, it is complex. NGOs have a responsibility: they need to look at impacts and not take risks. This representative presumes that pulse is better, but still it has unknown effects. Once decisions are made, they set the stage for the future.

A staff member of a politician says that competition between fishers and the politics that follow, is also an important consideration. In EU politics, it is France who blocks pulse. But they also said that if Dutch fishers would stop fishing in the Channel, we will not block pulse anymore. A representative of the Dutch fishing industry confirms that France wants them to stop using the flyshoot in the Channel.

The staff member of a politician says that research will never be enough if there are other concerns. He asks for the Dutch ministry opinion on this. Kees Verbogt responds by saying that the national level, only a small group was using the pulse. Twenty-two were using pulse successfully. Some fishers then started questioning the pulse technique, they regarded it as unfair competition. This was the main reason for the political pressure to increase the number of licences. The reason why the Netherlands ended up with 84 licenses is because once we had 42 issues, we had another 42 on a waiting list. It was important to have a level playing field on a national level. Now there also is a need for a level playing field at the international level. A few years ago Belgium was not sure what to do; it was a big debate. Belgian fishers could not use pulse, as they do not only fish in the North sea but also in other waters such as the Irish Sea where pulse is not allowed. These objections were not based on scientific concerns.

A representative of the Dutch fishing industry asks if we are talking about management of an innovation or management of a political process; the latter is managing politics. Having a level playing field makes sense. Kees Verbogt affirms that politics is another big issue that needs to be addressed. The Netherlands have taken big steps on control and science; management is the big remaining thing and the revision of the technical measures regulation will be an important part of this.

An employee of a standardisation institute asks how the question of creating a level playing field can be addressed. Managing politics is related to transparency. In the breakout session on Control and enforcement, the When we disused control in the earlier session the Netherlands Food and Consumer Product Safety Authority said they are open and transparent; standardisation could be a way to transparently share information. Standardisation would help in building the trust that is now lacking. Kees Verbogt says that standardisation and certification is recent development from the last 2 years, which the Netherlands are improving and investing in now.

A representative of the Dutch fishing industry asks what role can regionalisation play in innovation? Would it be possible to do something about this. For example, in the current situation Italy is talking about pulse fishing in the North sea. Why is this needed if they do not fish in this area. The Dutch industry wants to talk with the Member States around the North Sea. A representative from the policy field responds that currently groups of member states in the region, such as the North Sea countries, are leading the main regional regulations. Italy has no function in that process for the North Sea. If the North Sea Member states decide to push forward and if STECF gives a positive evaluation, then the Dutch can go forward and get a permit. There will be no interference of Mediterranean countries. In case of the overall technical measures regulations, however, all Member States have a say. Following an enquiry from the Dutch industry on the role of the European Parliament, the policy representative clarifies that pulse permission will be a delegated act which comes from the Commission. The Parliament has an oversight in that process; they do still have a veto.

Kees Verbogt says that in the morning session, there was a discussion that at a regional level, the least you can do is having one approach towards innovation. For example on which steps to take to come to acceptance. Another thing to do, for instance when there are sensibilities in a specific region (e.g., the use of pulse in a specific area), is to make a tailor made agreement. France, for example, could say 'we agree with pulse but as there is no support from the industry, we make an agreement not to fish in the French part of the North Sea'. This is what can be done on the regional level. He suggests that this maybe a way to manage the introduction of a new gear as well.

A representative of the Dutch fishing industry is not in favour of this line of thinking. In politics always someone has to pay a price: if you need something, you need to offer something. An NGO representative is of the opinion that science and other interests should be separated, which is considered to be a naive view by the staff member of politician. One of the scientists says that a risk assessment is the domain of science, but making the choice on the basis of the assessment is political. Kees Verbogt says that this is the reason for setting up the ISAC: to separate politics from science. Evelien Ranshuysen point out that you could have all the knowledge you need to have in place, but if it is framed incorrectly the mass thinks it is not good even though you have all the scientific evidence. An NGO representative concludes that there is a need for a benchmark and we should think about that together. The NGO representative is willing to take this responsibility.

A representative from the policy field likes the presentation slide showing the incentive is to use pulse on the one hand and the concerns on the other hand (Annex 7, slides 8 and 9). It is the role of science to inform the decision making process. The question also is: 'when is enough enough?' There is a judgement call to be made in the process and the question is: 'how do we support that process?' There may still be unknowns, but the whole it looks okay. As part of the support for the process leading to a judgement call, a matrix of parameters would be useful.

2.3 Conclusions

At the plenary closing session, Michel Kaiser presents the key points the ISAC members picked up from the break-out sessions:

1. A key question is when the scientific evidence is enough to move forward. Another workshop with a cross-section of people may be needed to address this question.
2. What level of uncertainty and risk are we prepared to accept? It is important to ensure that legislation is flexible enough so that regulations can be undone when one gets it wrong.
3. The way pulse fishing currently takes place in the Netherlands is a large experiment with a large fleet. It is important that scientists use this situation to maximise the opportunities the commercial fleet offers in collecting data.
4. There is the issue of control and enforcement. The control and enforcement team seems comfortable they can deal with it, but there will always be an arms race. This question is whether this can be prevented and one can be confident about this.
5. Innovation in the future should be possible. If the limits of the gears are set too hard, then this should not hamper further innovation and improvements.
6. In relation to the question of animal welfare, it is important that the research informs the debate on how many fish are subjected to injury relative to fish that would die anyway, so that it is put in perspective.
7. One has to be careful how to translate the science. For example, there is a question on whether or not pulse trawling drives fish away; fishing with a mechanical bottom-trawl, will cause mortality of benthos which increases food availability for fish. There is a point where science stops and politics comes in. What people see depends on their perspective and how they translate it.
8. The Dutch industry wants to be innovative. It would be useful if the European Commission would develop a manual or guidelines about the type of information that needs to be collected. Without a protocol it is difficult to make an agreed decision.

Michel Kaiser thanks all the participants for their contribution to the workshop and urges the participants to fill out the upcoming questionnaire.

Evelien Ranshuysen of the Ministry of Economic Affairs closes the meeting, thanking all for their participation, input and openness. Special thanks go to the session leaders, the people involved in organising and reporting the sessions and to the ISAC.

3 Quality Assurance

Wageningen Marine Research utilises an ISO 9001:2008 certified quality management system (certificate number: 187378-2015-AQ-NLD-RvA). This certificate is valid until 15 September 2018. The organisation has been certified since 27 February 2001. The certification was issued by DNV Certification B.V.

References

- de Haan D, Fosseidengen JE, Fjellidal PG, Burggraaf D, Rijnsdorp AD 2016. Pulse trawl fishing: characteristics of their electrical stimulation and its effect on behaviour and injuries in Atlantic cod (*Gadus morhua*). ICES Journal of Marine Science 73(6): 1557–1569
- ICES. 2016. Request from France for updated advice on the ecosystem effects of pulse trawl. Copenhagen, International Council for the Exploration of the Seas, 4 February 2016.
- Rijnsdorp, A., de Haan, D. de, Smith, S., Strietman, W.J. 2016. Pulse fishing and its effects on the marine ecosystem and fisheries. An update of the scientific knowledge. Wageningen Marine Research Report C117/16. Pp 32.

Justification

Report number: C016/17
Project number: 4318100130

The scientific quality of this report has been peer reviewed by a colleague scientist and a member of the Management Team of Wageningen Marine Research

Approved: Prof. Dr. A.D.Rijnsdorp
Senior researcher

Signature:

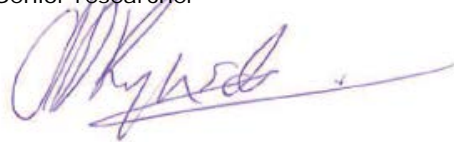

Date: 2nd March 2017

Approved: Drs. J. Asjes
Manager Intergration

Signature:



Date: 2nd March 2017

Annex 1 List of participants

	First Name	Surname	Function	Country
1	Yolanda	Arjona	Joint Nature Conservation Committee	UK
2	Jurgen	Batsleer	VisNed - PO industry	NL
3	Victoria	Bendall	CEFAS	UK
4	Jörg	Berkenhagen	Thünen institute	DE
5	Pim	Boute	PhD	NL
6	Peter	Breckling	Deutscher Fischerei Verband - PO industry	DE
7	Matthew	Cox	North Atlantic Fishing Company	UK
8	Debbie	Crockard	Marine Conservation Society	UK
9	William	Davies	Icelandic Seachill (& the Saucy Fish Co.)	UK
10	Dick	de Haan	Wageningen Marine Research	NL
11	Ger	de Ruiten	Low Impact Fishers of Europe NL	NL
12	Willem	de Waal	Low Impact Fishers of Europe NL	NL
13	Alyne	Delaney	International Advisory Committee Pulse Fishing	DK
14	Henk	Demkes	Netherlands Enterprise Agency	NL
15	Anne	Doeksen	Stichting de Noordzee - NGO	NL
16	Maarten	Drijver	VisNed - PO industry	NL
17	Walter	Duebner	Sea Fisheries Management and Control - Ministry	DE
18	Dan	Edwards	Joint Nature Conservation Committee	UK
19	Juliane	Eykelhoff	Netherlands Normalisation Institute	NL
20	Jordan	Feekings		DK
21	Bonita	Fruneaux	Ministry of Economic Affairs	NL
22	Norman	Graham	European Commission	EU
23	Meit	Grossmann	Permanent Representation of Estonia EU	EST
24	Heather	Hamilton	Client Earth	UK
25	Ingvild	Harkes	WWF	NL
26	Holger	Haslob	Thünen institute	DE
27	Jeanetet	Hervé	FranceAgriMer	FR
28	Lotte	Huisman	Stichting de Noordzee - NGO	NL
29	Manon	Joguet	FROM Nord (PO industry)	FR
30	Michel	Kaiser	International Advisory Committee Pulse Fishing	UK
31	Irene	Kingma	Nederlandse Elasmobranchen Vereniging - NGO	NL
32	Harm	Klein Wolthuis	HFK - Pulse engineer	NL
33	Raoul	Kleppe	Msc Student	NL
34	Erik	Kloster		
35	Jesper	Kobberholm	industry	DK
36	Marloes	Kraan	Wageningen Marine Research	NL
37	Martin	Lankheet	Wageningen University	NL
38	Erwin	Luitwieler	Delmeco - Pulse engineer	NL
40	Henri	Lund	Danmark Fiskeriforening Producent Organisation	DK
41	Geert	Meun	VisNed (PO Industry)	NL
42	Pieke	Molenaar	Wageningen Marine Research	NL
43	Marieke	Mossink	Ministry of Economic Affairs	NL
44	Corrie	Nagel	Industry	NL
45	Johan	Nooitgedagt	NVB - PO industry	NL

	First Name	Surname	Function	Country
46	Philipp	Oberdoerffer	Erzeugergemeinschaft der Deutschen Krabbenfischer	DE
47	Tjeerd	Olie	European Parlement	EU
48	Guus	Pastoor	Visfederatie (industry)	NL
49	Hans	Polet	Institute for Agricultural and Fisheries Research	BE
50	Evelien	Ranshuysen	Ministry of Economic Affairs	NL
51	David	Ras	VisNed - PO industry	NL
52	David	Reid	International Advisory Committee Pulse Fishing	IE
53	Adriaan	Rijnsdorp	Wageningen Marine Research	NL
54	Dale	Rodmell	National Federation of Fishermen's Organisations	UK
55	Peter	Sandoe	University of Copenhagen	DK
56	Lennert	Schrader	Netherlands Food and Consumer Product Safety Authority	NL
57	Maximilien	Simon	Ministry of Environment (Fisheries)	FR
58	Victor	Simoncelli	Marine Stewardship Council	UK
59	Joana	Smith	Natural England	UK
60	Maarten	Soetaert	Institute for Agricultural and Fisheries Research	BE
61	Nathalie	Steins	Wageningen Marine Research	NL
62	Daniel	Stepputtis	Thünen institute	DE
63	Wouter Jan	Strietman	Wageningen Economic Research	NL
64	Despina	Symons	European Bureau for Conservation & Development	EU
65	Kees	Taal	Van der Zwan BV (industry)	NL
66	Tsjerk	Terpstra	European Parlement	EU
67	Justin	Tiano	PhD	NL
68	Brita	Trapman	NVB - PO industry	NL
69	Mike	Turenhout	Wageningen Economic Research	NL
70	Wouter	van Broekhoven	VisNed - PO industry	NL
71	Richard	van Buuren	Netherlands Food and Consumer Product Safety Authority	NL
72	Durk	van Tuinen	NVB - PO industry	NL
73	Kees	Verbogt	Ministry of Economic Affairs	NL
74	Bart	Verschueren	Institute for Agricultural and Fisheries Research	BE
75	Antony	Viera	COPECHE - PO industry	FR
76	Pim	Visser	VisNed - PO industry	NL
77	Frederieke	Vlek	Greenpeace NL	NL
78	Lutz	Wessendorf	Bundesanstalt für Landwirtschaft und Ernährung	DE
79	Gunnar	Wolff	European Commission	EU
80	Christopher	Zimmermann	International Advisory Committee Pulse Fishing	DE
81	Edwin	de Bruin	Delmeco - Pulse engineer	NL
82	Guus	Hecke	Delmeco - Pulse engineer	NL
83	Job	Schot	EMK - Fisheries Sector	NL
84	Cas	Caljouw	EMK - Fisheries Sector	NL

Annex 2 Presentation Lotte Huisman:
NGO perspective

Pulse fishing - an NGO perspective

International Dialogue Meeting
Amsterdam, January 20th 2017

The North Sea Foundation coordinates NGO stakeholder communication



NGO reservations and concerns about pulse



1. Potential impacts not understood



2. No effective control and enforcement



3. Pulse in Natura 2000



4. Irresponsible upscaling has damaged trust



5. Single-minded focus on pulse

Addressing the problems – our wishes:

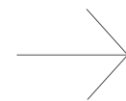
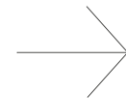
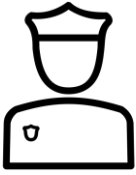

1. Research is key: no expansion, licence renewal or lifting limitations before knowledge gaps are resolved.
2. Effective control & enforcement: clear technical requirements, C&E procedures and penalties.
3. Access depends on appropriate assessment: in line with Habitats Directive.
4. Lessons learned inform future processes: transparency, stakeholder involvement, timely scientific assessment.
5. Pulse is not the only solution: openness and resources for innovation, comparison to other gear.

We need a vision on the transition
towards sustainable fisheries

What?

How?

When?

Annex 3 Presentation Pim Visser:
Developments Dutch flatfish
fleet

Dutch Demersal Fisheries

developments in a historical perspective



Pim Visser

Executive Officer VisNed

Overview

- History and developments
- Technical Innovation as part of Dutch DNA
- Innovative fisheries management

- NB this is Dutch (his)story no prescription !



the Netherlands if pumping stops

History

Original industrial fisheries on herring

- Starting 16th century
- Important source of protein for the population
- Shoal fish easy to catch
- Preservation since invention of 'jawing' of herring
- Large number of vessels
- Basis for "Golden Age" economy

Regional Spread



Zuiderzee with many ports
now reclaimed land
now inshore lake
islands disappeared (Urk)

Coastal beach areas
Southern Estuaries

Fisheriestradition Coast

- Young tradition
- Abt. 1900: migrating herring caught from the beach



Fisheriestradition Northern Holland

- Sailing 'Botters' using renewable energy and trawlnets



Fisheriestradition Northern Holland

- Closure Zuiderzee > migrating fishermen



Closure of fishing areas



Around WW II and early 50's

- Poverty
- Diesel engines bring a solution



Innovation through Beamtrawl

- Traditional bottomtrawl fisheries

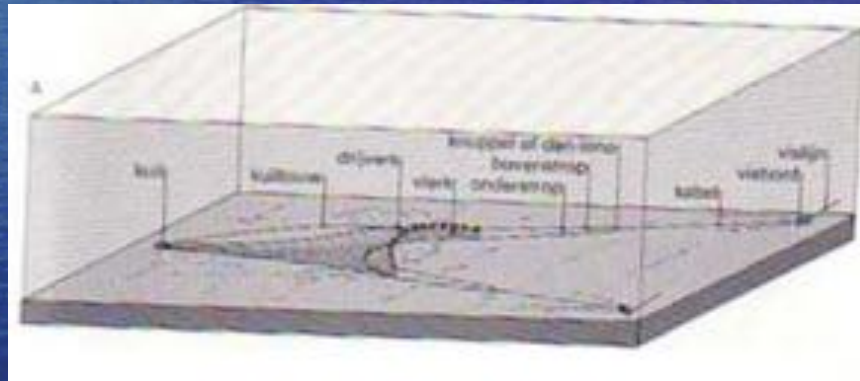

Beamtrawls increases efficiency

- Originating from shrimp fisheries

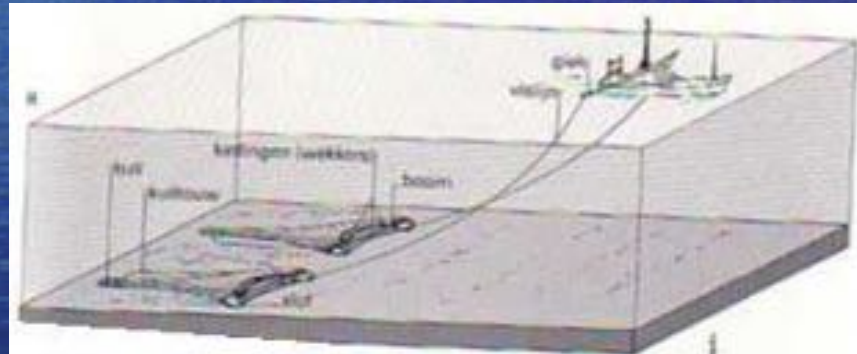

The Beamtrawl late 50's

- Increase of scale
- Sole and Plaice major species
- Casualties because technology failed



The Beamtrawl-boom in the 60's

- Increased fleet



The Beamtrawlfleet expansion 80's

- Development of safe vessels
- Abundance of fish, unlimited supply



Beamtrawlfleet reduction since 1990's

	<u>1990</u>		<u>2014</u>
Number of vessels	588	↓↓	276
Total engine power	586.000	↓↓	212.000
kW days	>40.000.000	↓↓	≈ 21.000.000

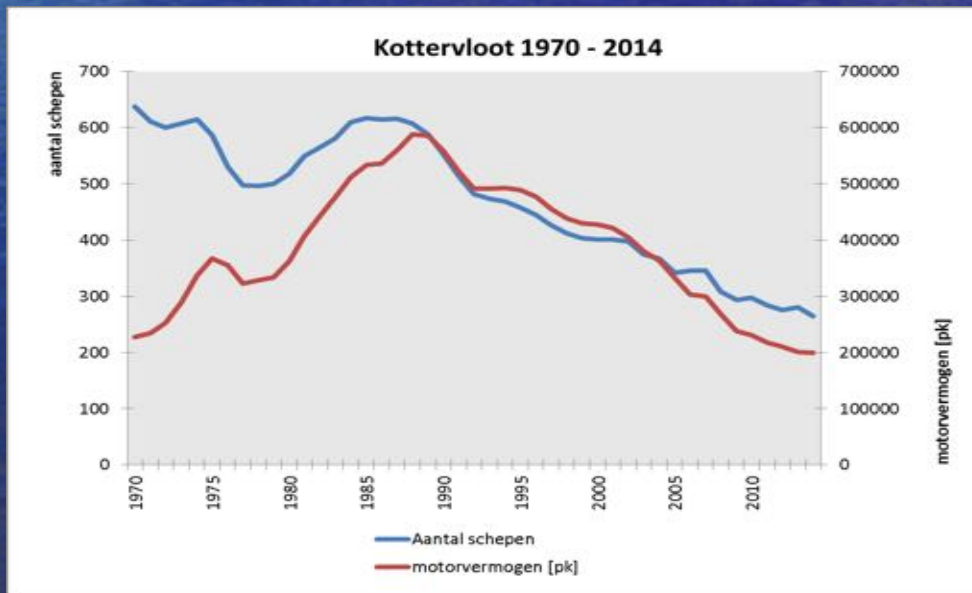

Development of North Sea CFP

- NL got 38% of EU plaice TAC
- NL got 75% of EU sole TAC
- NL has 90% of EU plaice processing
- TAC too small for our modern fleet

Resulting late eighties

- Illegal catches illegally sold
- Invention of the 'grey circuit'
- Late eighties heavy confrontations between fishermen and government (riot police in ports!)

Getting out of the deadlock

- 1993 co management of quota by way of regional groups
- Since 2014 embedded in the new CMO

- !! Government and PO's each have their own role to play

North Sea Sole

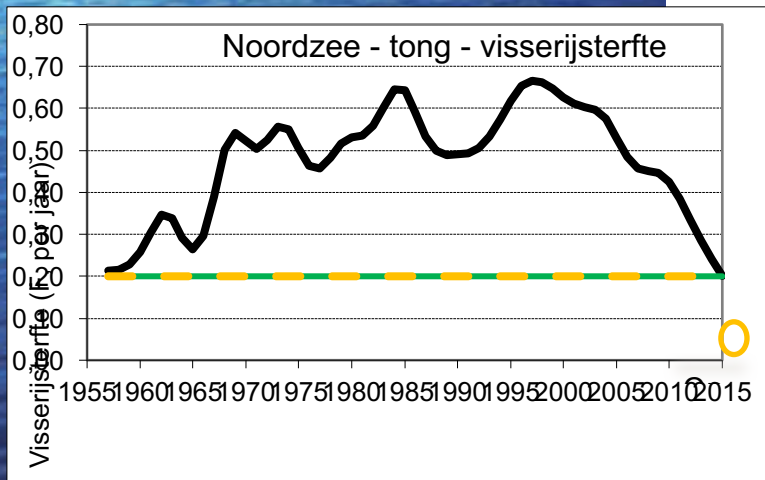
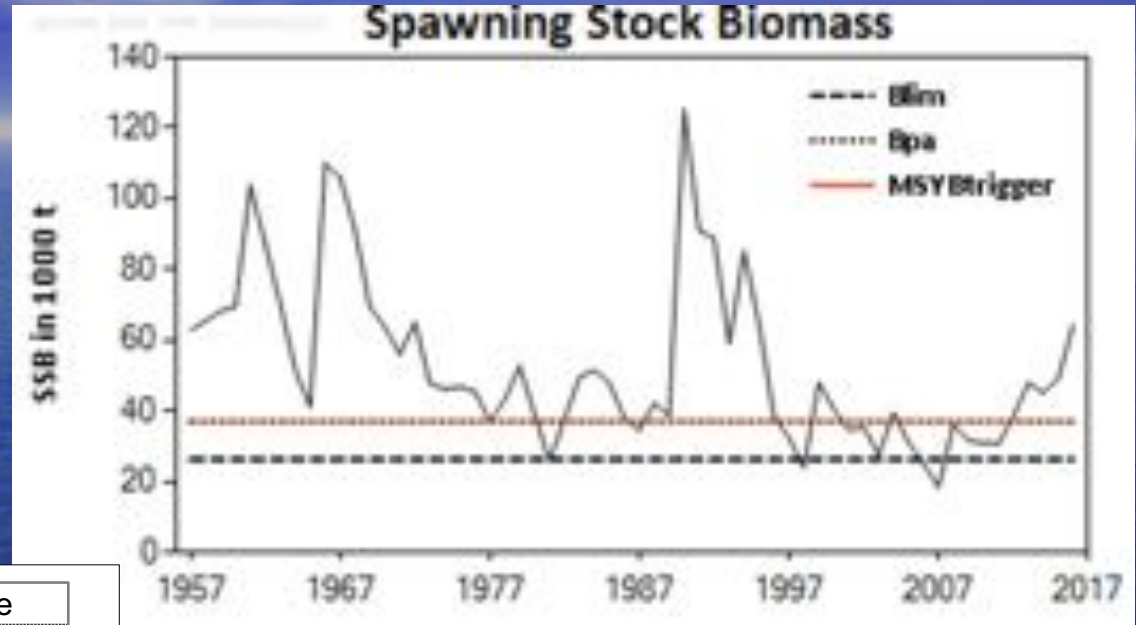

Concentration and Diversification

- Changes in Fishing pattern and species
- Concentration of ITQ's
- Increase of 'mixed seasonal fisheries'
- Flexible fleet of Holland transited
 - Large beamers 60% reduced transition to pulse
 - Multi purpose Eurocutters
 - TwinRig/Fly Shootvessels
 - Shallow draft shrimpers

Evolving fisheries management

- Since 1993 co management of quota
- Since 2014 embedded in the new CMO
- 2016 co management extended to N2000 compliance
 - 2016 Pelagic sector signed MOU with Greenpeace
- 2017 PPP in Research, Landing Obligation etc
- !! Government and PO's still have their own role to play

Dutch Demersal Fisheries

pulse fisheries in a historical perspective

(we need to keep our feet and country dry)



Annex 4 Presentation Harmen Klein
Wolthuis: The pulse system

Pulse system

What's behind the scenes?

Introduction

- ▶ Suppliers HFK Engineering and Delmeco
 - ▶ Knowledge about pulse fishing
 - ▶ About logic and science
- 

The discovery

- ▶ When electric pulses are applied on seawater, (flat) fish react by contracting their muscles
- ▶ Verburg Holland together with Imares started discovering the boundaries of pulse fishing

Principle design

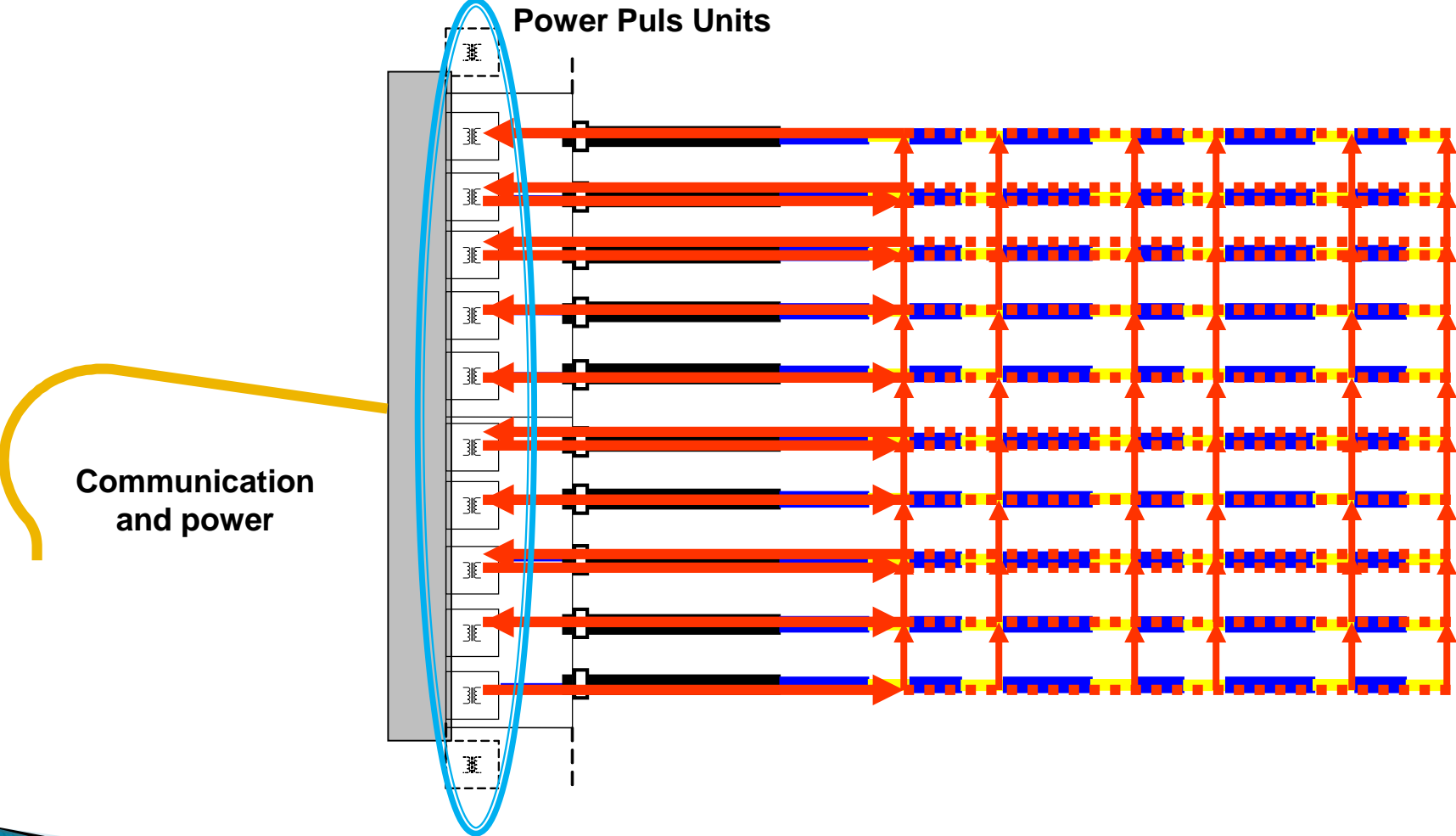

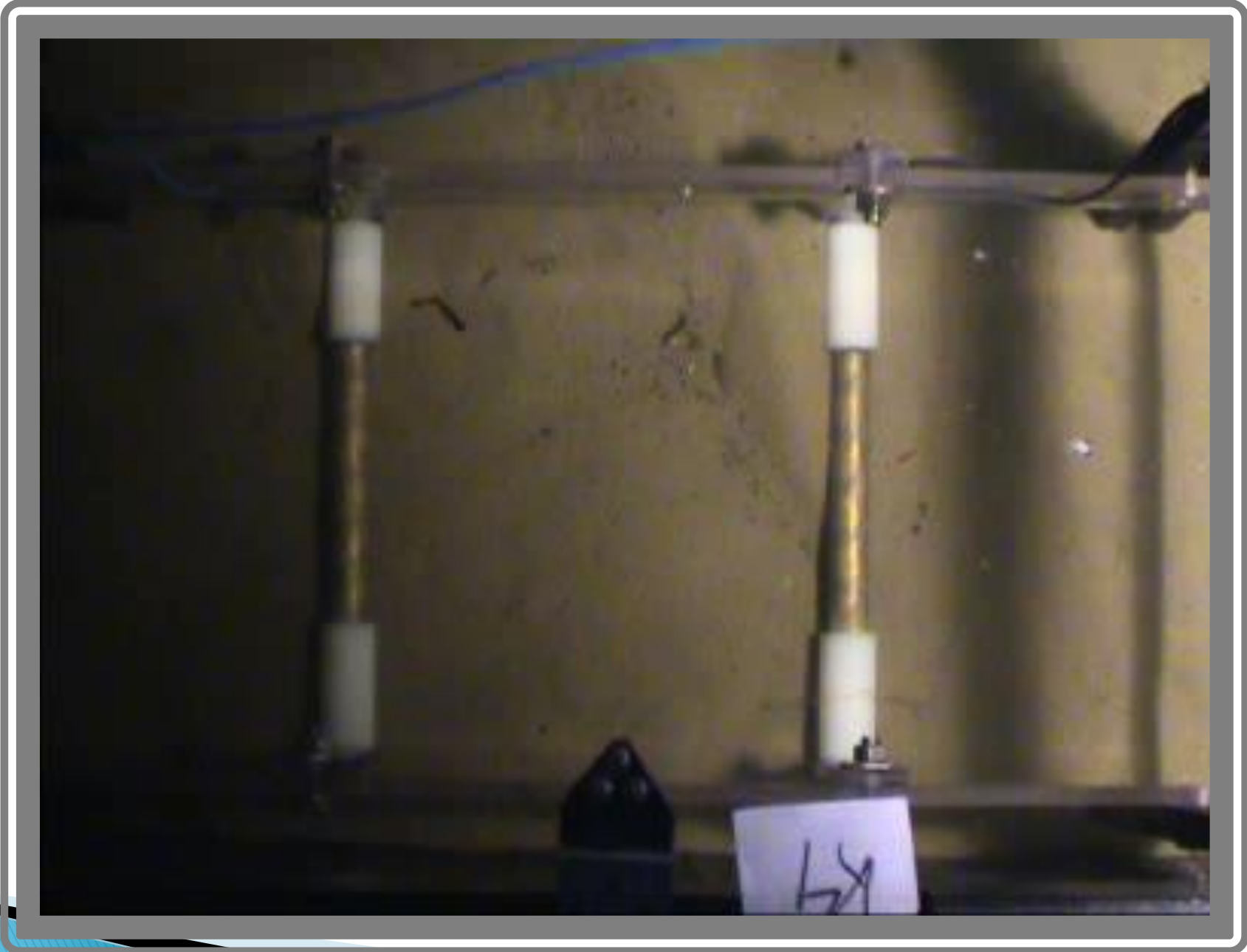

The goal

- ▶ Use electricity to stimulate flatfish to leave their shelter in the seabed

Time line

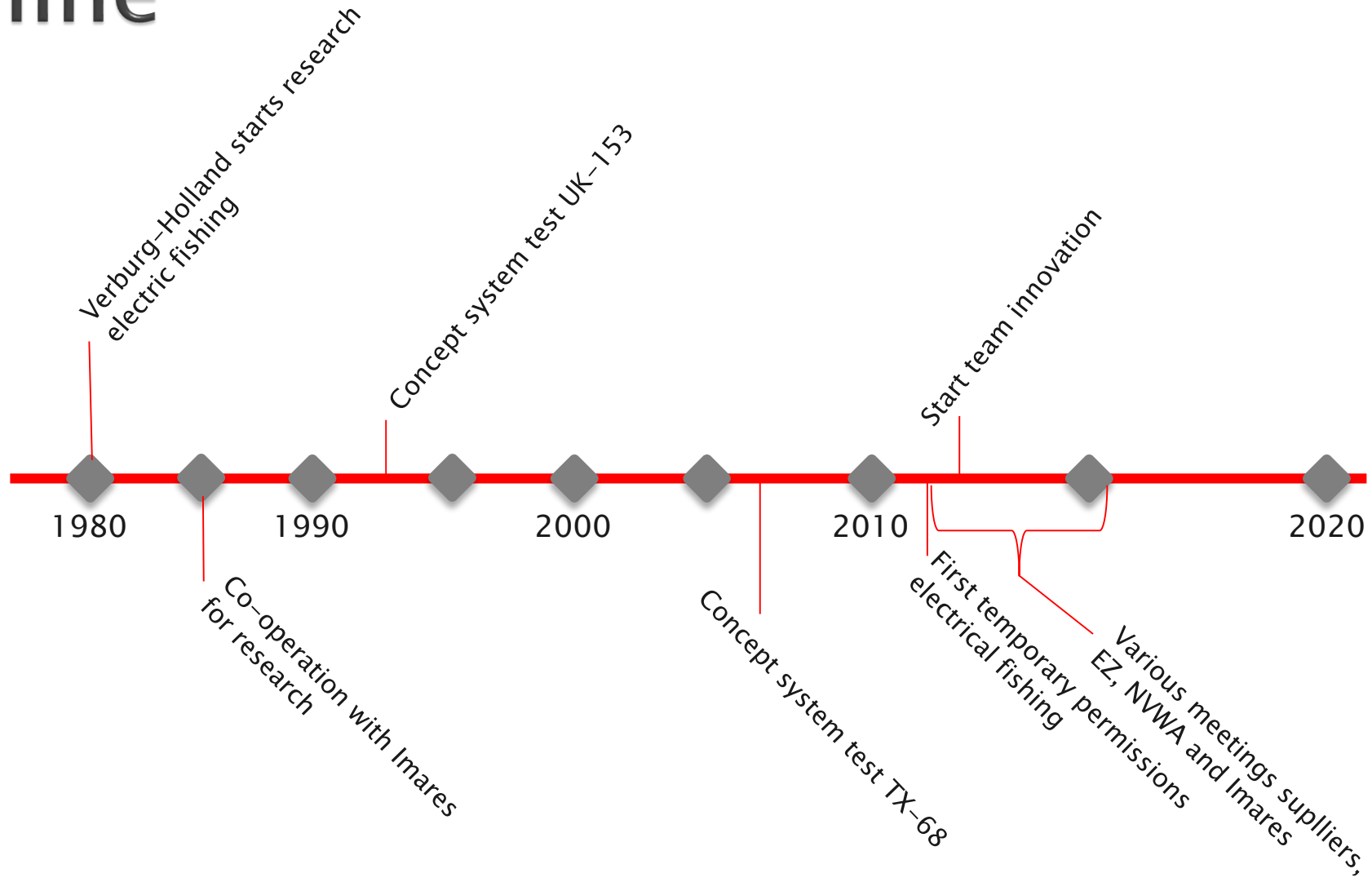

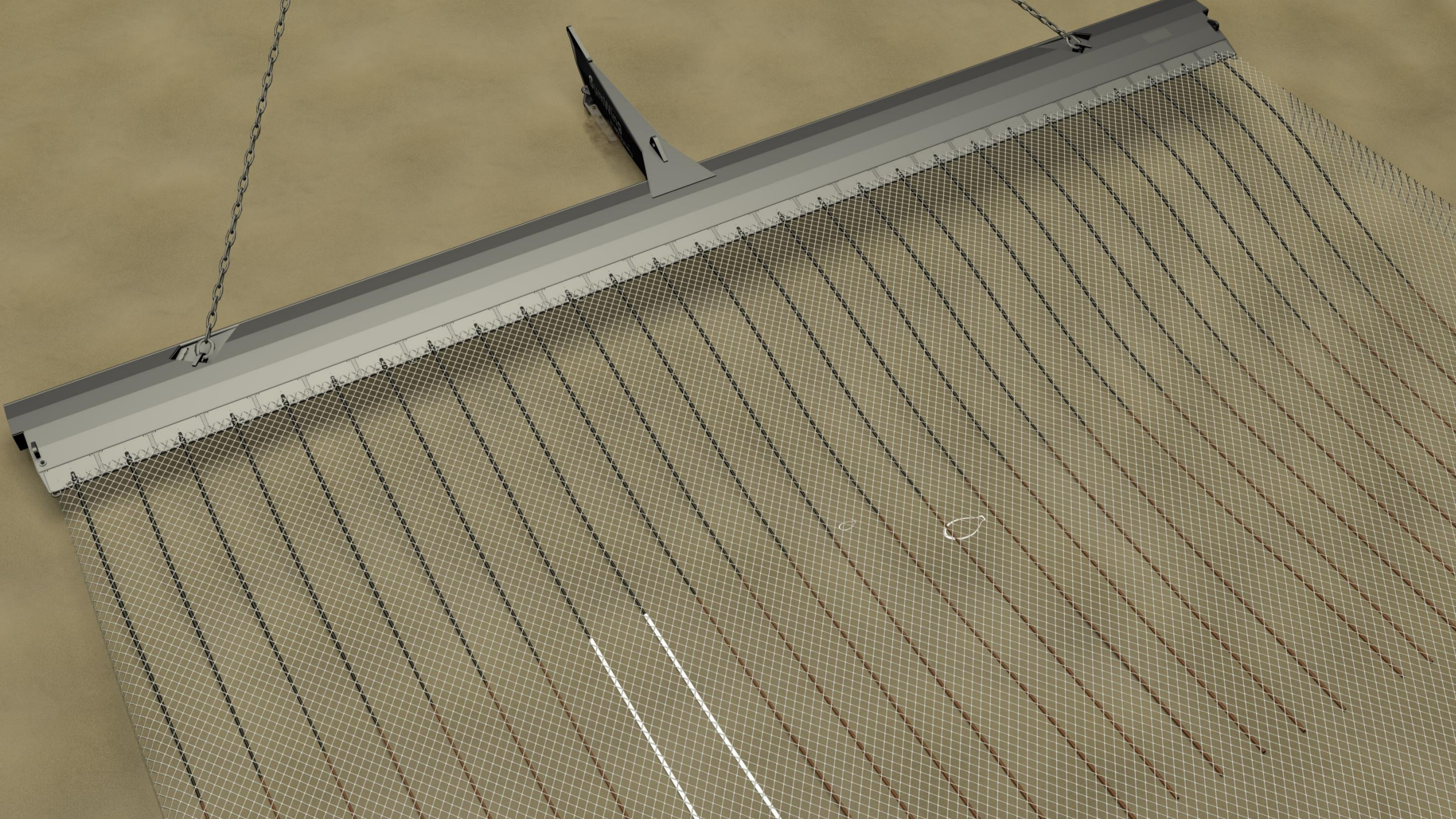

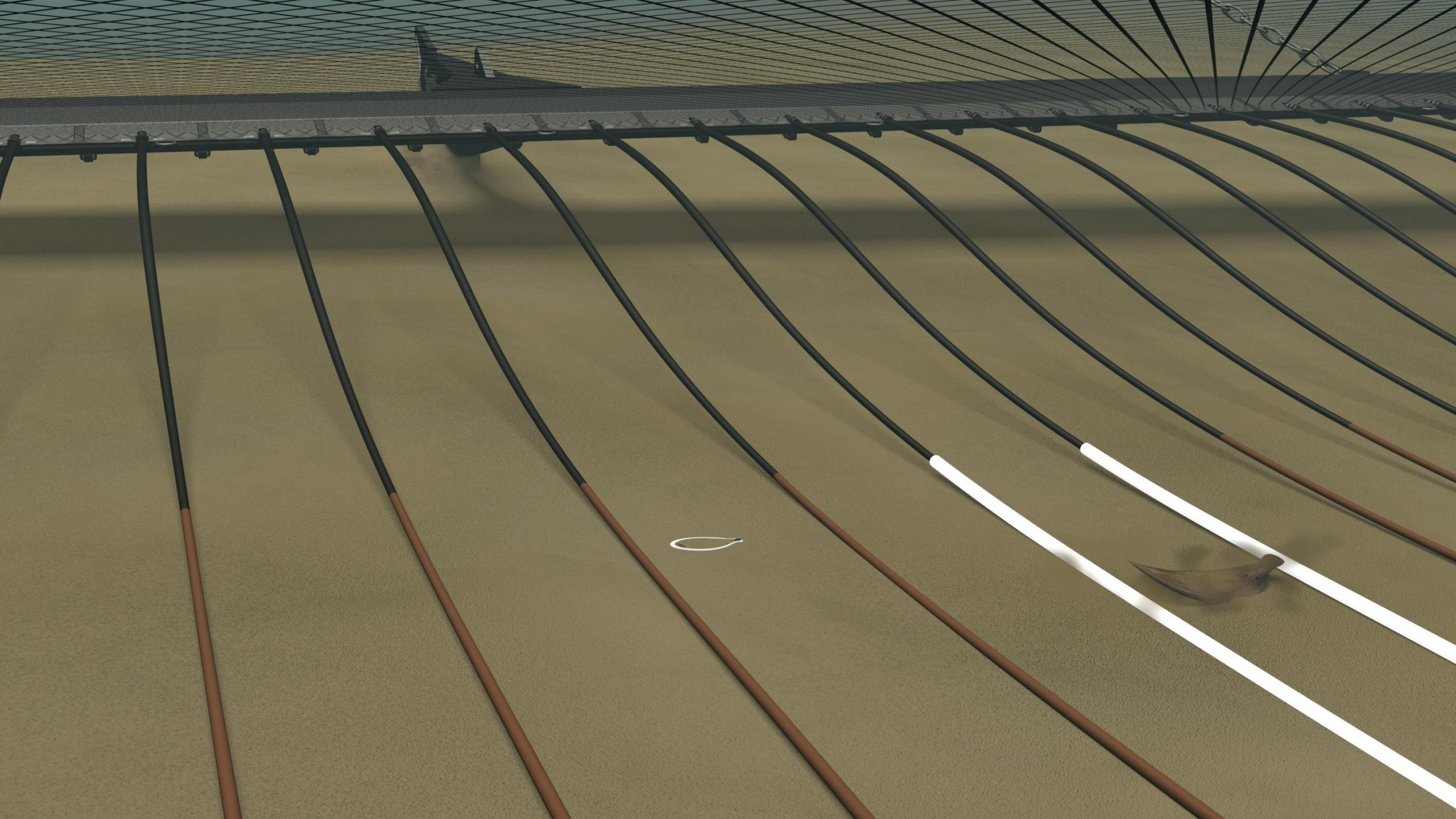

3 major benefits

- ▶ Discard reduction
- ▶ Reduction of seabed disturbance
- ▶ Fuel and CO² reduction

CO² and Fuel

- ▶ Tickler chains versus electrodes
- ▶ Reduced speed

- ▶ Introduction of pulse fishing reduces CO² emission by 212.000.000 kg

Gas

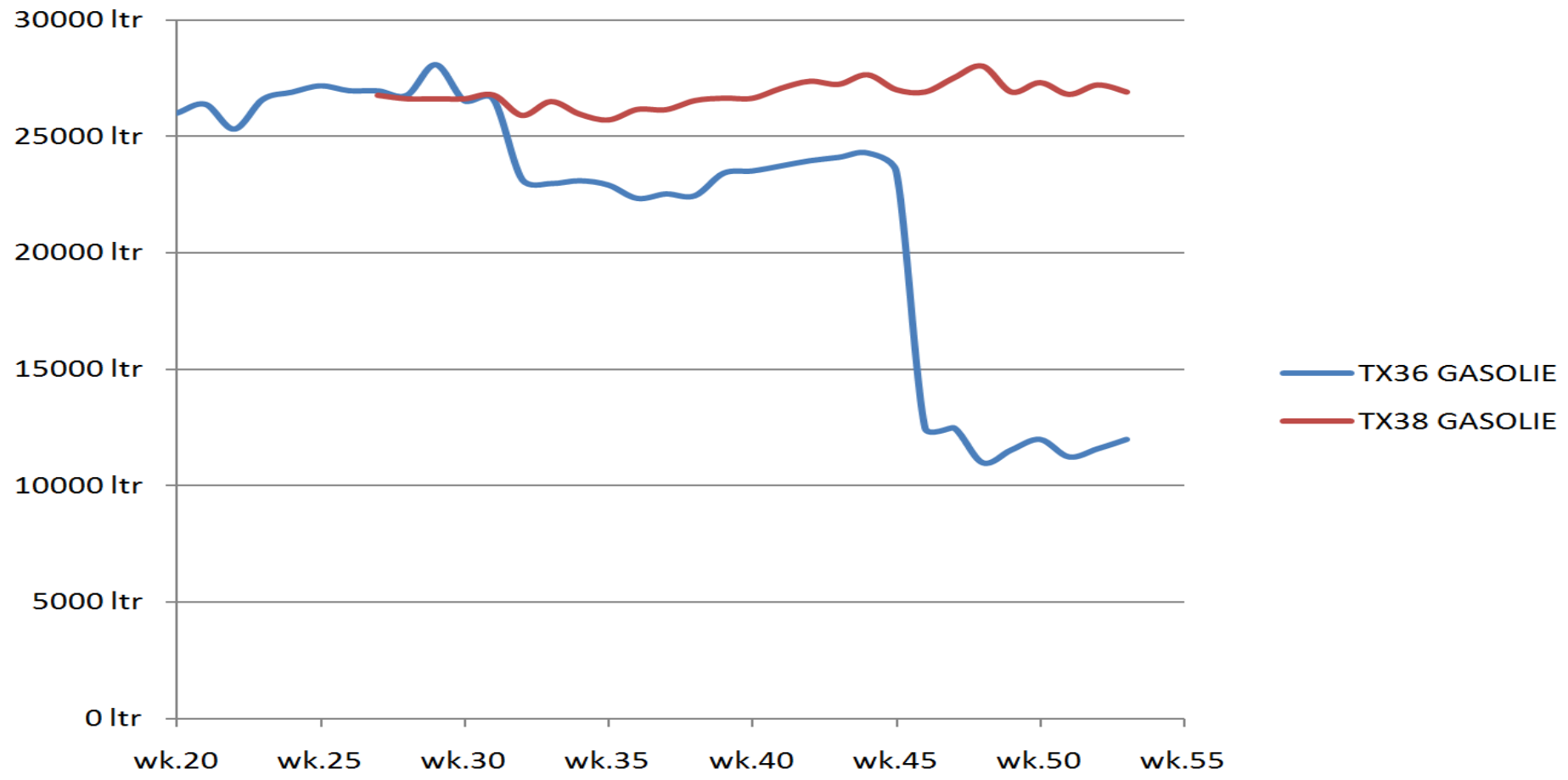

Electricity in salt water

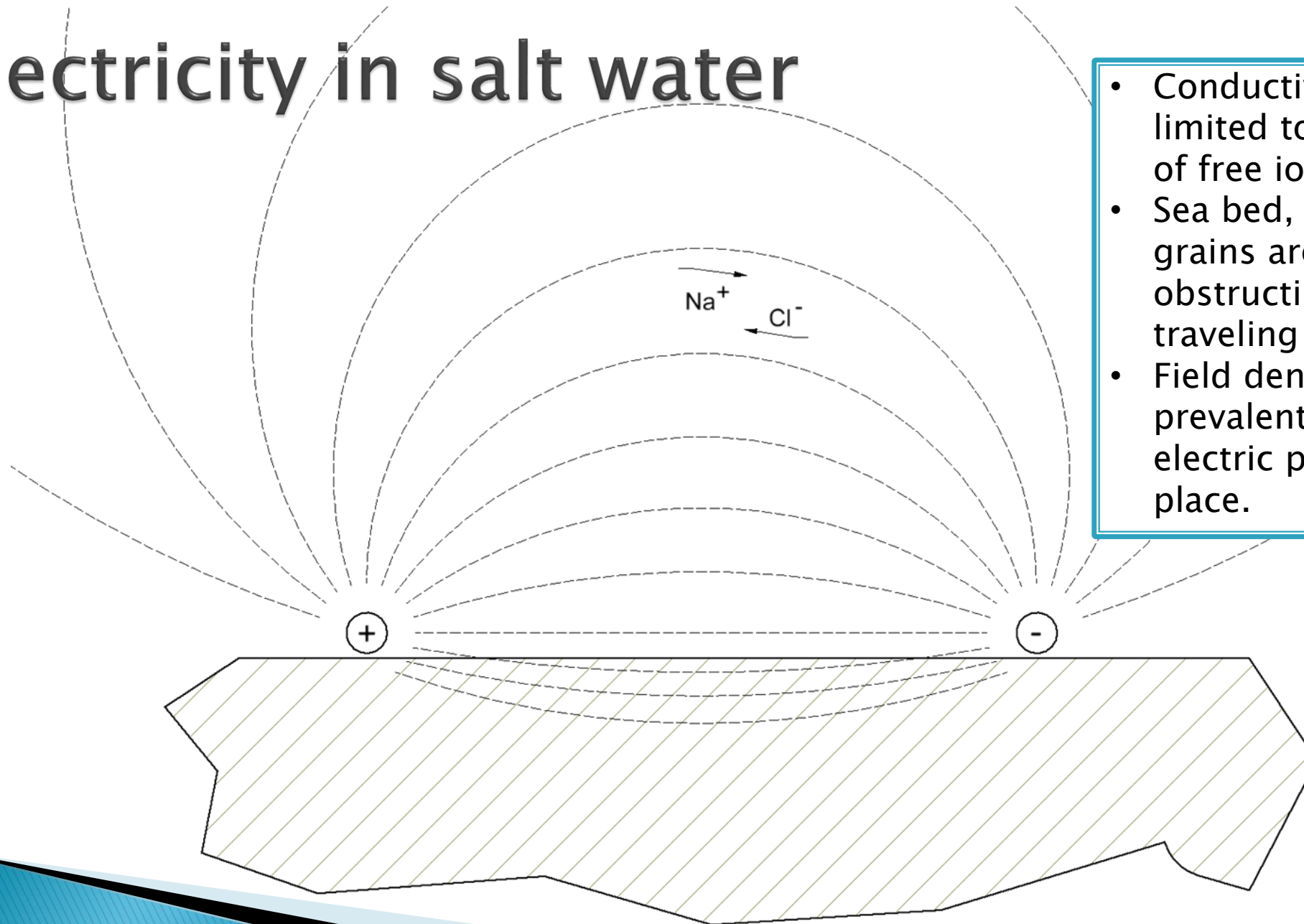

- Conductivity is limited to amount of free ions.
- Sea bed, sand grains are obstructing traveling ions.
- Field density is prevalent for electric potential at place.

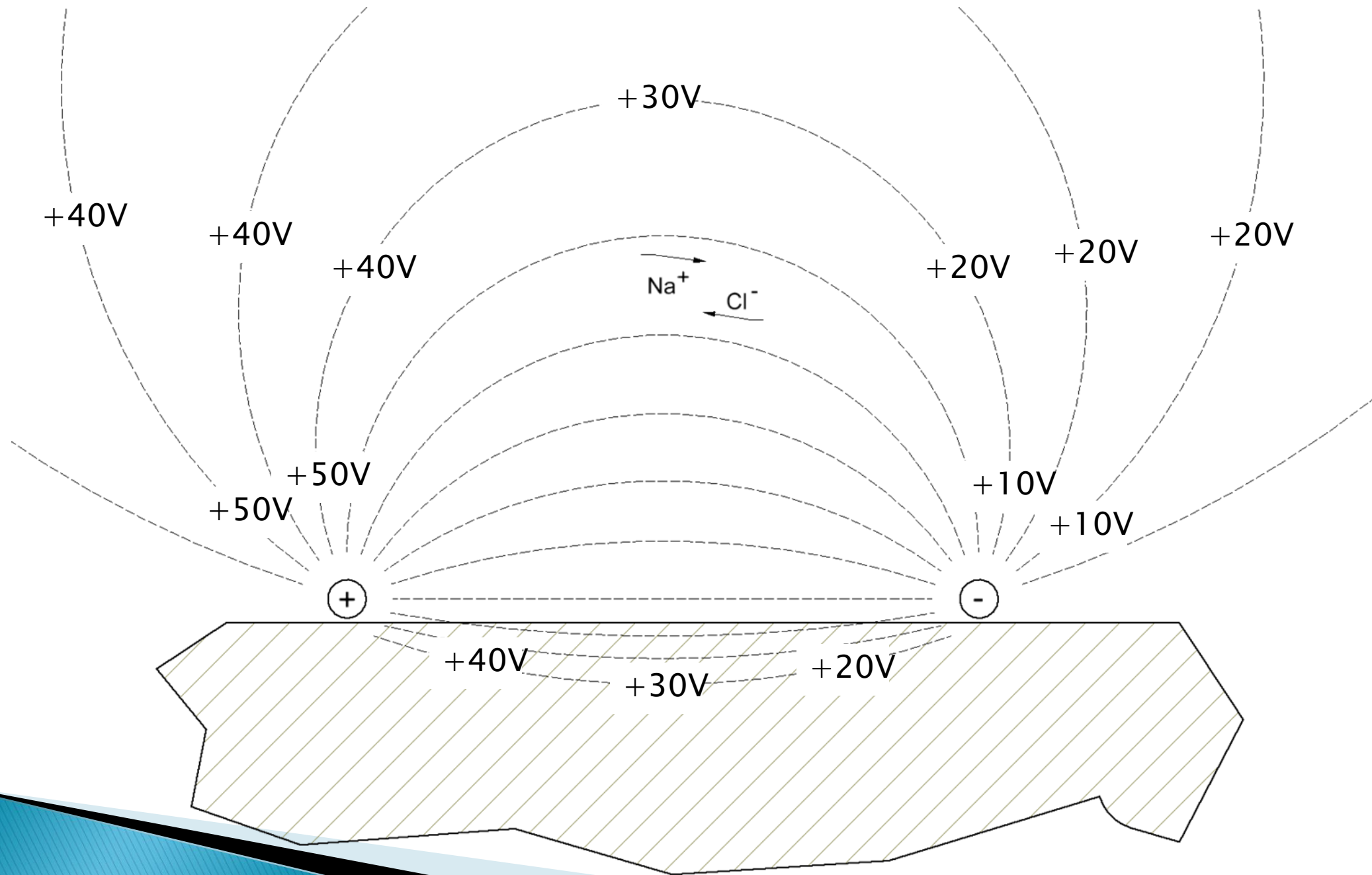

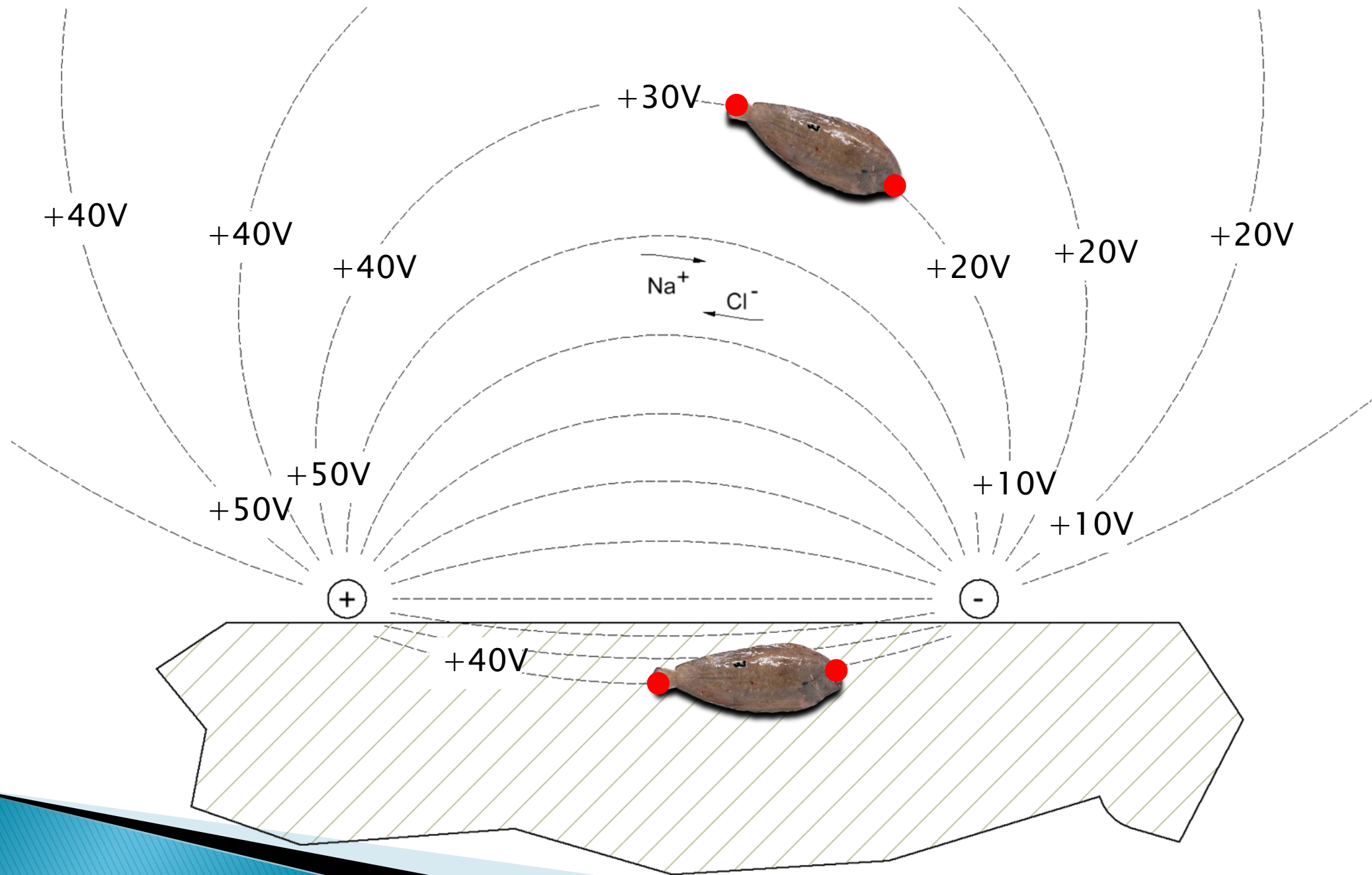

Effect on fish (example)

Fish in seabed

- ▶ Tail potential = 30V
- ▶ Head potential = 40V
- ▶ Voltage measured over the fish, $40V - 30V = 10V$

Fish above electrodes

- ▶ Tail potential = 28V
- ▶ Head potential = 24V
- ▶ Voltage measured over the fish, $28V - 24V = 4V$

Conclusions

- ▶ Effect is depending on size.
 - ▶ Effect is depending on place.
 - ▶ Effect is depending on orientation.
 - ▶ Effect is stronger in the surface of the seabed.
- 

The effects (positive)

▶ Science

- A lot has been studied and studies are still being made.
- Discards reduced by approx. 35%
- Catch rates the same or less.

▶ Logic

- Stones and other materials don't react on electricity, nets stay "cleaner" therefore:
 - discard escape chance a lot better (proved in scientific studies)
 - Fish more lively on deck (come and see for yourself)
 - Fish are less damaged or crushed in the net (proved by trade prices)

The effects (positive, continued)

▶ Logic

- Electrical potential is spread in the seawater
 - Small fish are not stimulated, discards will be caught less (proven in studies)
 - Small benthos is hardly stimulated

The effects (negative)

▶ Science

- Spinal damage can occur with cod in size of approx. 40cm to 60cm

▶ Practice

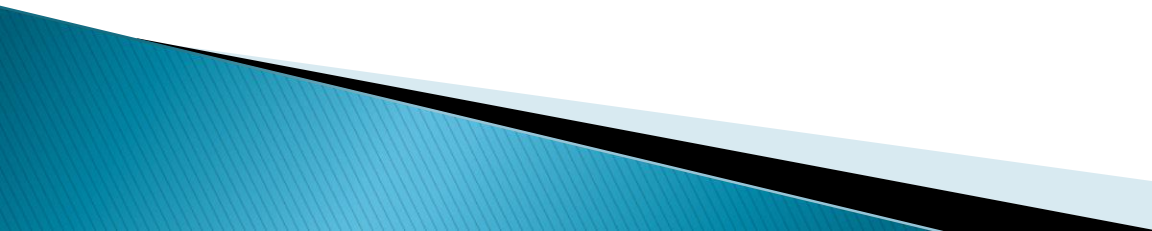
- Spinal damage does occur with cod.
 - Cod is caught less by the pulse system due to reduced speed and coverage.
 - Spinal damage does not occur with smaller cod.
- 

New legislation

▶ Science

- Studies prove that field strength is related to effects.
- Studies prove that frequency is related to effects.
- Studies prove that duty cycle is related to effect.

▶ Logic

- Field strength x frequency x duty cycle = power

New legislation (continued)

- ▶ Power is limited to 1 kW per meter gear width
- ▶ In addition every parameter is limited individual:
 - Field strength (diameter electrode (max 40mm), electrode distance (min 40cm) and amplitude (max 60V))
 - Frequency (min 20 tot maximum 180 pulses per second)
 - Duty cycle (maximum 3%)

Questions

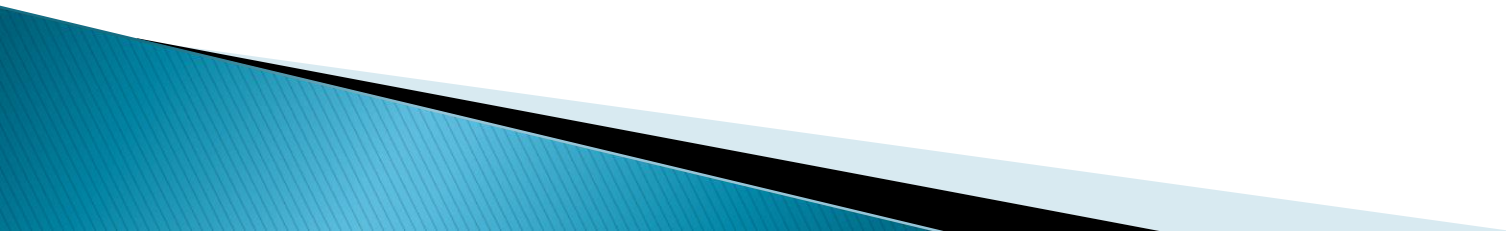

More information

[Pulsefishing.eu](https://pulsefishing.eu)

Annex 5 Presentation Adriaan Rijnsdorp:
Pulse research in hindsight and
forecast

Pulse fishing: setting the scene – research in hindsight and forecast

Adriaan D. Rijnsdorp (Wageningen Marine Research)

Mike Turenhout (Wageningen Economic Research)

20 January 2017



Question

- Can the replacement of mechanical stimulation (beam trawl) by electrical stimulation to reduce the ecosystem effects of fishing and improve selectivity?

- What do we need to know to answer this question?

- Pulse trawl
 - Mechanical disturbance (= trawl)
 - Electrical effects
 - Catch efficiency and selectivity

Pulse fleet: overview

- Pulse licenses (2016):
 - 79 active (from 84);
 - 59 flatfish; 16 flatfish + shrimp; 4 shrimp
- Effort flatfish fisheries
 - Reduction from ~34 to ~ 25 million hp-days since '08
 - Change in spatial distribution
- Economic: increased profits (reduction fuel use)
- Catch efficiency & selectivity
 - Earlier results of lower bycatch not supported
 - Increase in catch efficiency for sole suggested
- Survival sole and plaice discards higher

Effort

- Flatfish fisheries around 75% total effort cutterfleet

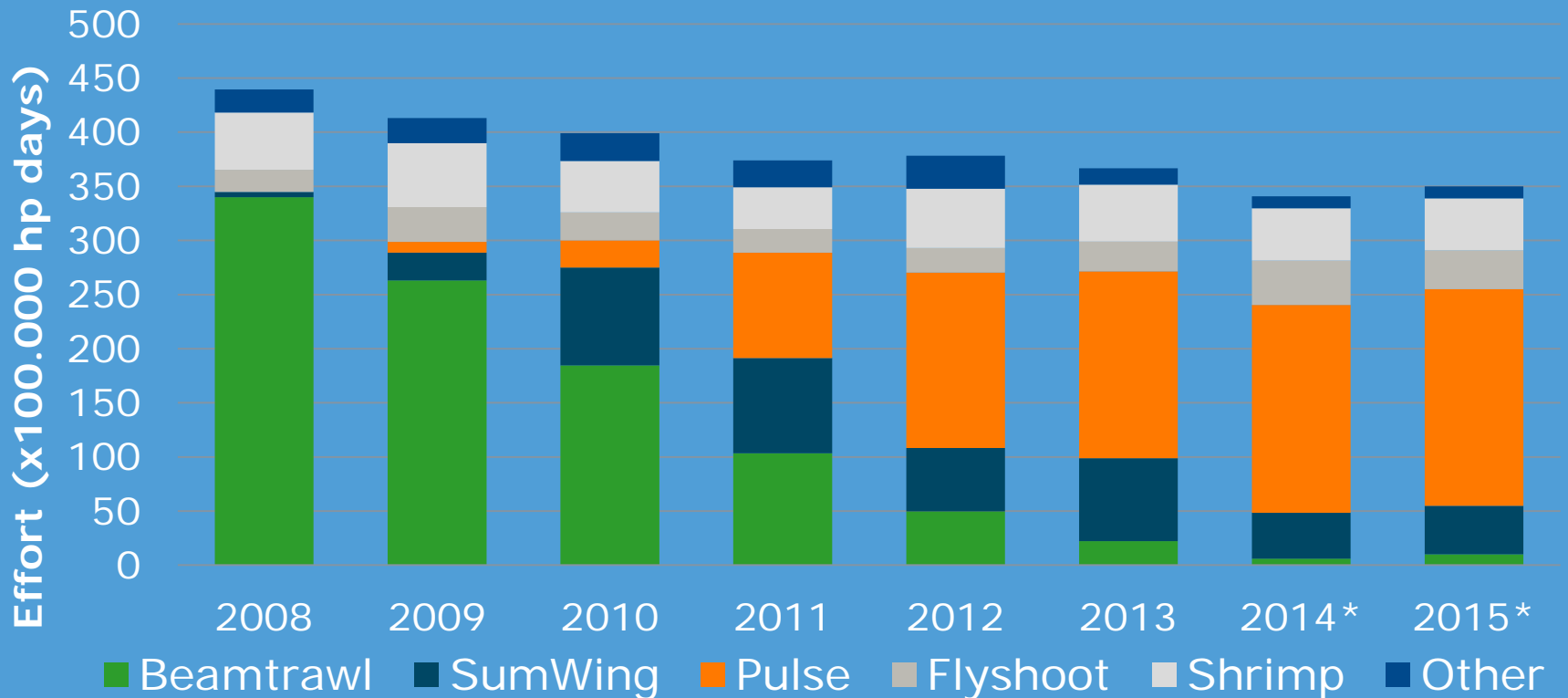

Mechanical effects

- Trawling impact on sea-floor and benthic ecosystem
- Design of the gear
 - Tickler chains – electrodes
 - Ground rope
- Pulse trawl:
 - lighter gear
 - lower towing speed: ~25% reduction in footprint
 - reduced penetration (Depestele et al 2016)
 - but wide diversity in rigging of the gear
- Assessment expected from FP7-BENTHIS project this year

Effects of electricity

- Dedicated pulse trawl research
 - Wageningen Marine Research (de Haan, van Marlen, et al.)
 - ILVO (Polet, Verschueren, et al.)
 - 2 PhD's University Gent (Soetaert, Desender)
- Physiology of electrical stimulation:
 - Excitation of neurons and muscles
 - Over-excitation
 - neurons → epileptic seizure
 - muscles → cramp → fracture / bleeding
 - Behaviour response: avoidance / attraction



Sole pulse exposure experiments

- Autopsy 14 days after exposure: various organs checked for lesions / irregularities using histology, X-ray, macroscopic
- Cod: no direct mortality, variable fracture rate in different experiments , effect of body size suggested
- Sole: no mortality, no lesions
- Seabass: no mortality, no fractures / lesions
- Catshark: no mortality; food detection ability not affected
- Ragworm: no mortality, no lesions
- Shrimp (single exposure): no mortality, increased virus infection
- Shrimp (multiple exposure): lower survival, no virus infection

Effect pulse parameters on fracture probability

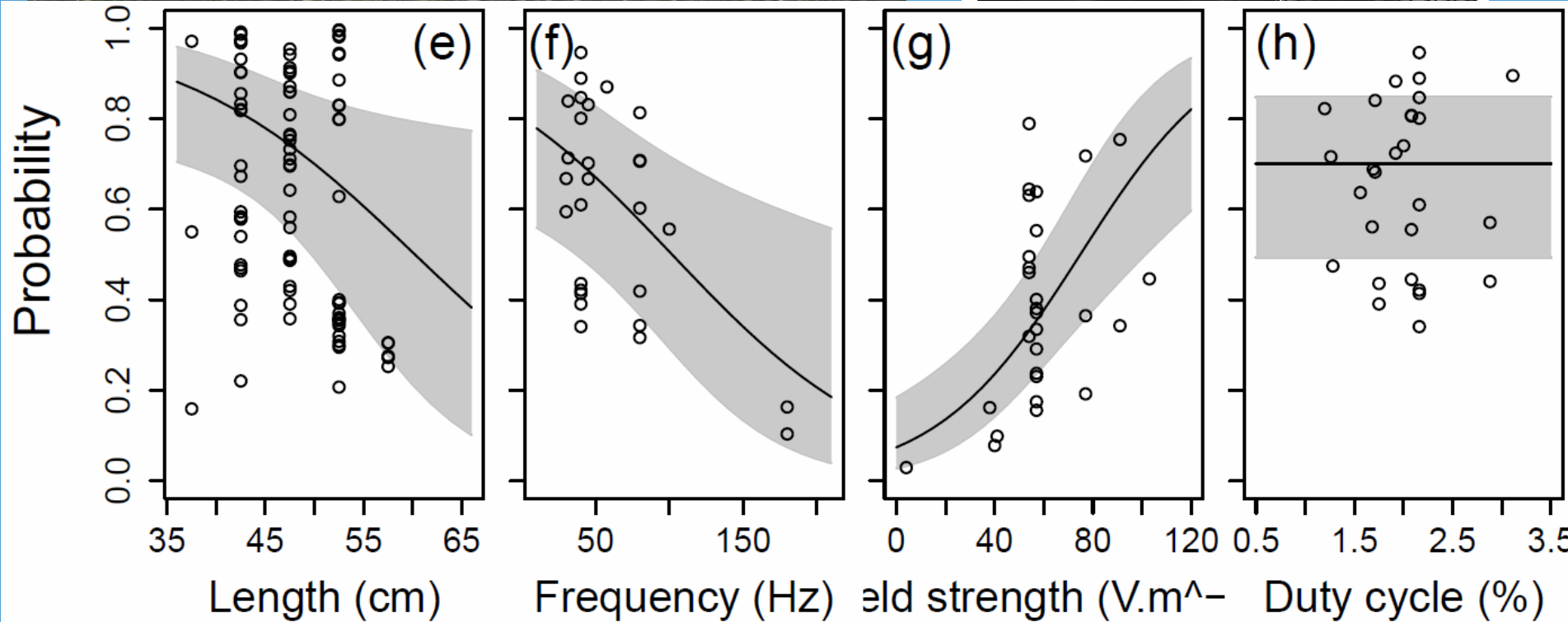
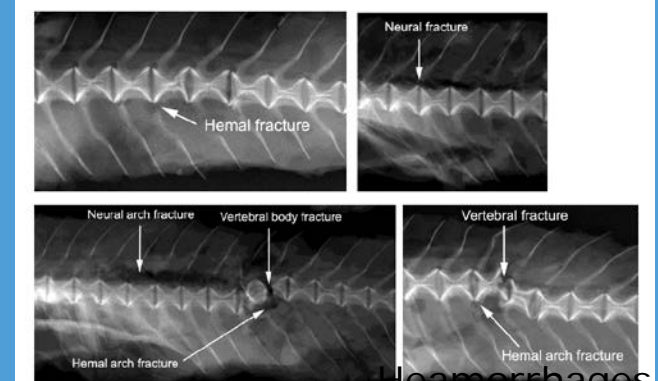

Shrimp pulse exposure experiments

- Autopsy 14 days after exposure: various organs checked for lesions / irregularities (specify) using histology, X-ray, macroscopic
- Plaice & Sole: no mortality, no lesions (except small haemorrhage in 2 of 25 plaice)
- Cod: no mortality; no lesions (except increase melano-macrophages in cod spleen)
- Bull-rout & Armed bulhead : no mortality; no lesions
- Shrimp & ragworms: no mortality, no lesions
- Egg (3 stages) & larvae (4 stages): hatching, mortality, development
- Sole : no effects
- Cod : adverse effect in 1 eggs stage & 1 larval stage, no developmental deformities

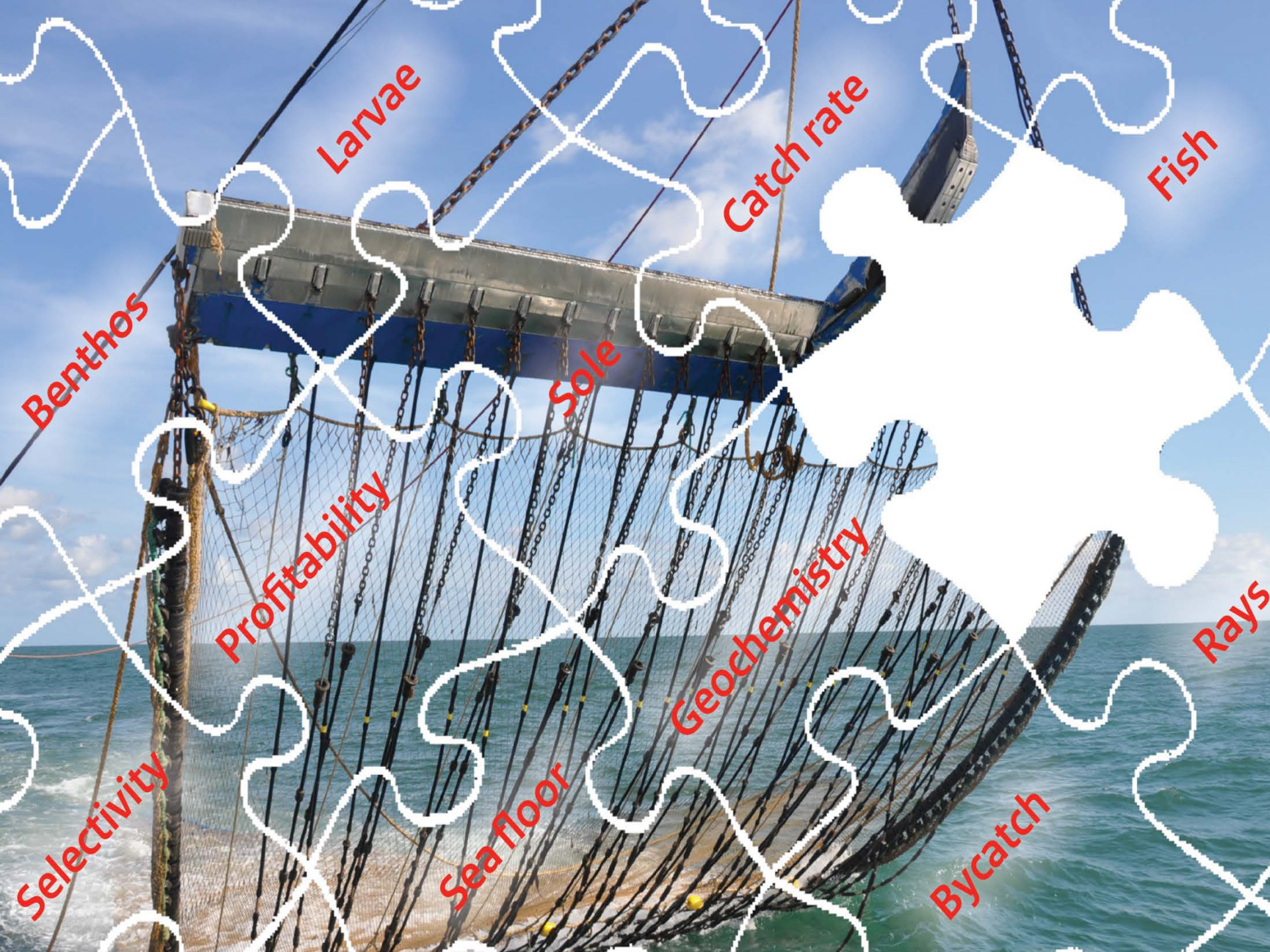

Larvae

Catch rate

Fish

Benthos

Sole

Profitability

Geochemistry

Rays

Selectivity

Sea floor

Bycatch

Pulse Trawl Research:

■ Objectives:

- Provide a scientific basis to assess the consequences of the transition of beam trawling to pulse trawling on the ecosystem effects (bycatch, benthos, ecosystem functioning) and sustainable exploitation

■ Project

- Field strength measurements
- Catch – effort data collection (2017+)
- PT assessment project (4 years)
- Discard monitoring & survival
- Economic performance



Photo: Hugo Schuitenmaker

Measurements of the electric field

Horizontal plane

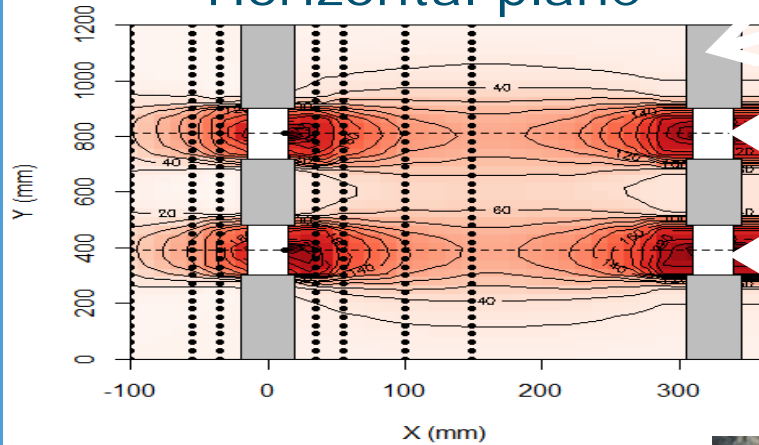

Isolator

Conductor

Field strength in vertical plane
Above and in the sediment

De Haan et al.
(2016)



Pulse Trawl Impact Assessment (2016-19)

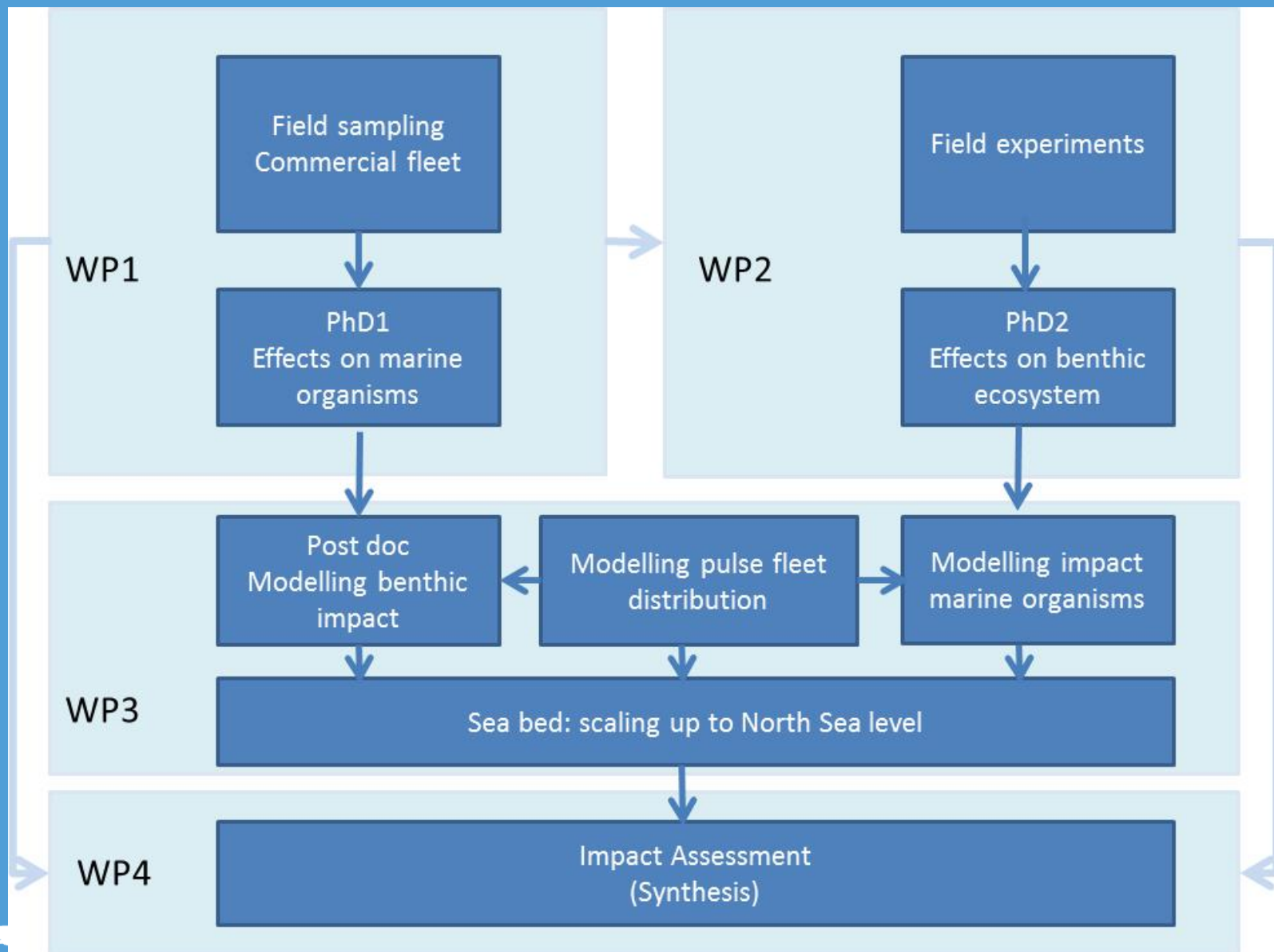

PT Impact Assessment: research questions

■ Marine organisms

- what is the response of selected marine organisms to the exposure by a range of pulse parameters?

■ Benthic ecosystem

- what is the effect of pulse trawling on the functioning and biogeochemistry of benthic ecosystems (short-term and long-term effects)?

■ 'Sea bed'

- what is the effect of pulse trawling on the fish stocks and the benthic ecosystem at the scale of the North Sea

■ Synthesis

- what is the effect of the transition of the tickler chain beam trawl fleet to a pulse trawl fleet on the bycatch of undersized fish and on the adverse effects on the benthic ecosystem?



1. PhD - Modelling the effects of pulse stimulation on marine fish and invertebrates

- Wageningen University (Experimental Zoology: Pim Boute PhD, Martin Lankheet, Johan van Leeuwen)
- Objective
 - To develop a general quantitative framework for predicting effects of pulse stimulation for different groups of animals, including flatfish, roundfish, elasmobranchs and different groups of invertebrates
- Approach
 - Lab experiments (fish, benthos)
 - Modelling

Research philosophy: mechanistic approach

Fish as an electrical circuit

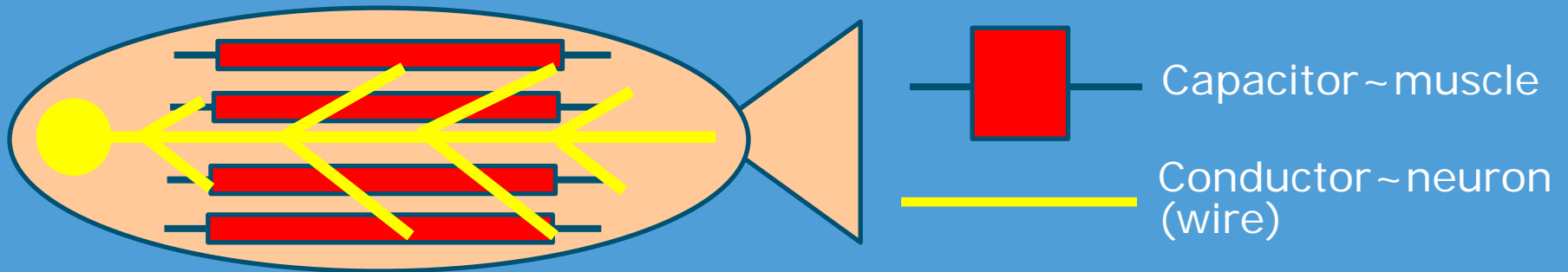

2. PhD - Differential effects of electrical pulse and conventional beam trawl fisheries on sediment biogeochemistry

- NIOZ (Justin Tiano PhD, Karline Soetaert, et al.)
- Objectives
- Assess the effect of electrical pulse trawl and beam trawl fishing on benthic ecosystem functioning, in particular on sediment biogeochemistry (short-term and long-term effects).
- Develop a predictive mechanistic model of the impact of beam trawl and electrical pulse fisheries on benthic-pelagic coupling

Effects on geo-chemistry:

laboratory, incubation field samples, field measurements(landers)
controlled trawling of study sites

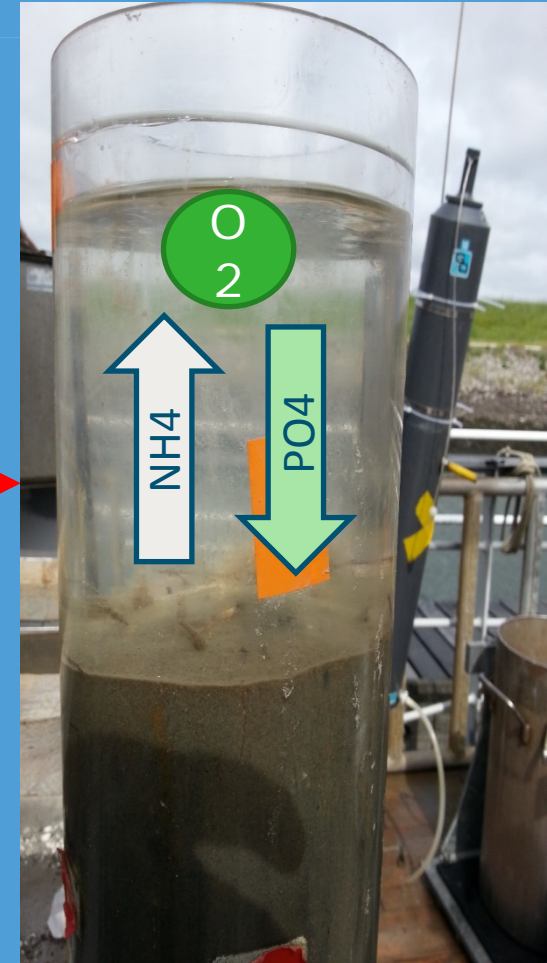
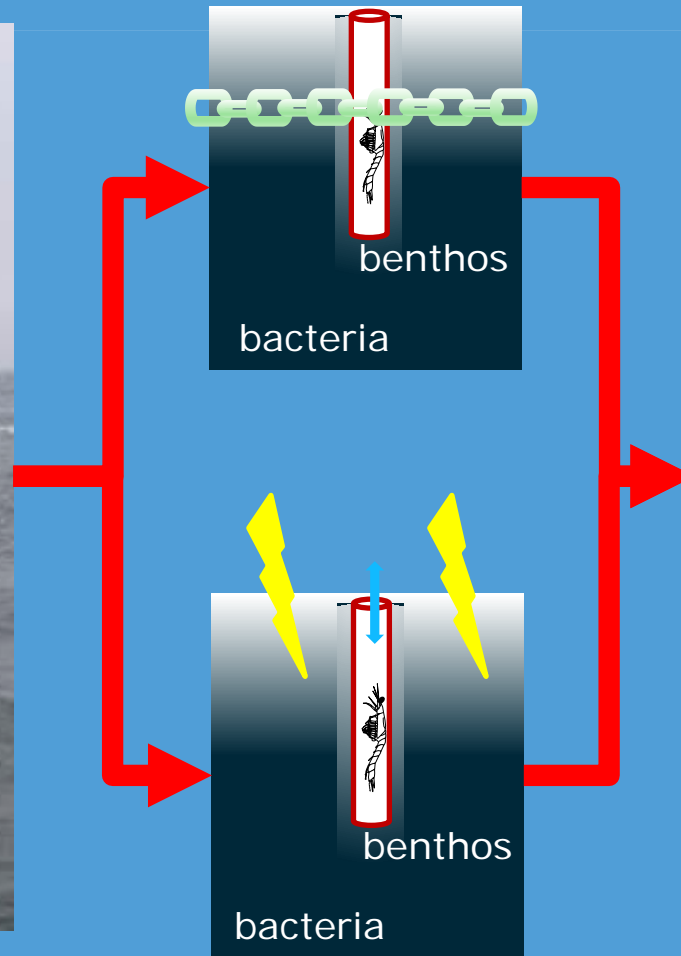
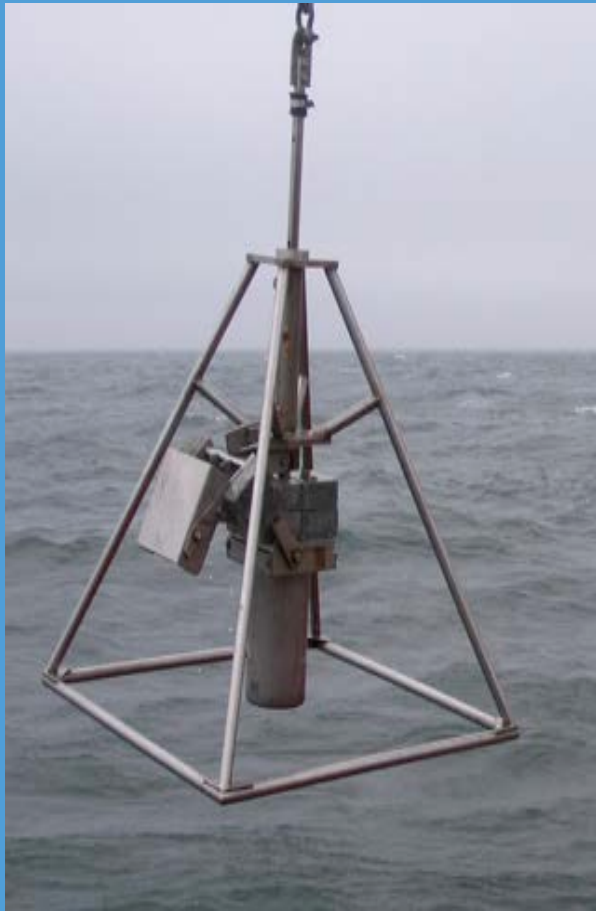

3 – Sea bed: scaling up the effects of pulse trawling to the North Sea level

- Wageningen Marine Research (Rijnsdorp, van Kooten, Teal, Hintzen, Poos, de Haan, et al)
- Objective
 - To develop a predictive framework to scale up the effect of pulse trawling to the level of the population and the ecosystem
- Approach
 - Modelling spatial distribution pulse trawl fleet in relation to benthic habitats (high resolution)
 - Modelling effect pulse trawls on ecosystem functioning

4. Impact assessment (2019)

- Effect of the transition of the tickler chain beam trawl fleet to a pulse trawl fleet will be estimated on the bycatch of undersized fish and on the adverse effects on the benthic ecosystem
- Scenario evaluation flatfish fleet
 - Pulse trawl
 - Tickler chain beam trawl

Annex 6 Presentation Richard van
Buuren: Control & enforcement
pulse fishery



Netherlands Food and Consumer
Product Safety Authority
Ministry of Economic Affairs

Pulse Fishing

A challenge for enforcement?

Drs. Richard van Buuren
Netherlands Food & Consumer Product Safety Authority

International Dialogue Meeting Pulse Fisheries



1 Ship
2 Rhips
35 inspectors



Pulse Fishing; time for a new enforcement approach

How to enforce by fishery inspectors ?

- New technique....
- Electrical equipment....
- At sea or in the harbour....
- In the water or in the air....
- At what temperature....
- Salt conditions....
- Manipulation of equipment....
-



Pulse Fishing, historical developments.....

Starting from scratch;

- Technique, gear, permits **and** enforcement
- Step by step approach
- Parallel development



Pulse Fishing, step by step.....

Bringing together

- Ministry and Marine ecological research institute?
 - › *Who determines the max output power?*
 - › *Allow pulse only for flatfish or other species as well?*
 - › *What to do with the effects on species?*
- Manufacturers....
 - › *Who determines the new standard?*
- Manufacturers and Ministry
 - › *Who determines the minimum requirements?*
- Manufacturers, Ministry and Enforcement
 - › *What is realistic to enforce on?*
 - › *Re-defining the requirements.....(again)*



Re-defining the requirements

In order to accommodate effective control and enforcement the pulse requirements have been updated several times.

This required a practical translation of complex technical matters in order to make it possible for fisheries inspectors to enforce these requirements.





Legislation vs more defined pulse requirements....

One example:

Council Regulation 850/98 states in Article 31a (2) (c) that:

“the effective voltage between the electrodes is no more than 15 V”



From legislation to requirements

This “effective 15 V” is impossible to measure in practice.

Therefore our technical experts have calculated a graphic figure which gives the same result, but can be measured.



From legislation to requirements

With the following result:

“The peak voltage of the pulse must not exceed 60V, measured between the connections of the electrodes and pulse modules”

This can be measured.



From legislation to requirements

Interpretations seems to be logical, but...

- Feedback to the marine research institute...
- Feedback to the manufacturers...

Resulting in...

- Modified requirements in the licenses,
- Modified equipment

Remains complex, to discuss all these parameters with all involved in this matter..



From legislation to requirements

The requirements are more elaborate than the legislation and backed by research:

Modified requirements, described in the Technical files on board, with specs;

- electrode composition & size
- the insulator
- the duty-cycle
- Etc.



Legislation vs requirements...

Static legislation and Dynamic requirements

How to combine...?



Standardization

The entire process of standardization and making new pulse requirements had another benefit. It connects industry, manufacturers, ministry and enforcement authorities.

Creating wider support for enforcement!



Standardization

How to enforce on standardized products?

Enforce on all....

- Ships?
- Gears?
- Units?
- Electrodes?
- Data loggers?
- ...



Certification

For those units which cannot be measured by the data logger, an obligation to have the units certified by an accredited institution has been introduced (5d).

This ensures compliance.



Certification

For those units which can be measured by the data logger, an obligation to have the electronically figures certified by an accredited institution has been introduced (5d).

This ensures compliance.



Licensing

- The number of licenses for pulse fisheries is restricted.
- The new pulse requirements also enable the enforcement authorities to suspend, or withdraw, the license in case of non-compliance.
- Strong tool to enforce compliance!



6 Flap overs; give your opinion about....

1. What do you deem appropriate sanctions in case of non compliance?
2. How would you stimulate self-control by the pulse fleet?
3. I deem control of the requirements easy/difficult.
4. I would organize control as follows:
5. What innovative control tools would you suggest?
6. Certification (and normalisation) is the way forward in (pulse) fisheries control.



Questions?

Annex 7 Presentation Kees Verbogt: Scope and regionalisation



Ministry of Economic Affairs

**Pulse
Fishing**



Elaboration:
Innovation and
regionalisation
within the EU – a
broader scope

January 20, 2017

4 Fisheries and aquaculture production | 4.4 Or

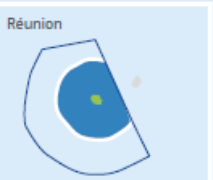
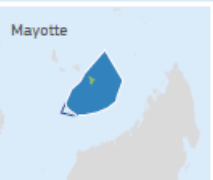

- Baltic Sea
- Black Sea
- Long Distance Fleet (non-EU waters worldwide)
- Mediterranean Sea
- North Sea
- North-Western waters
- South-Western waters
- Outermost regions
- Pelagic stocks (blue whiting, mackerel, horse mackerel, herring, boarfish)
- EU waters

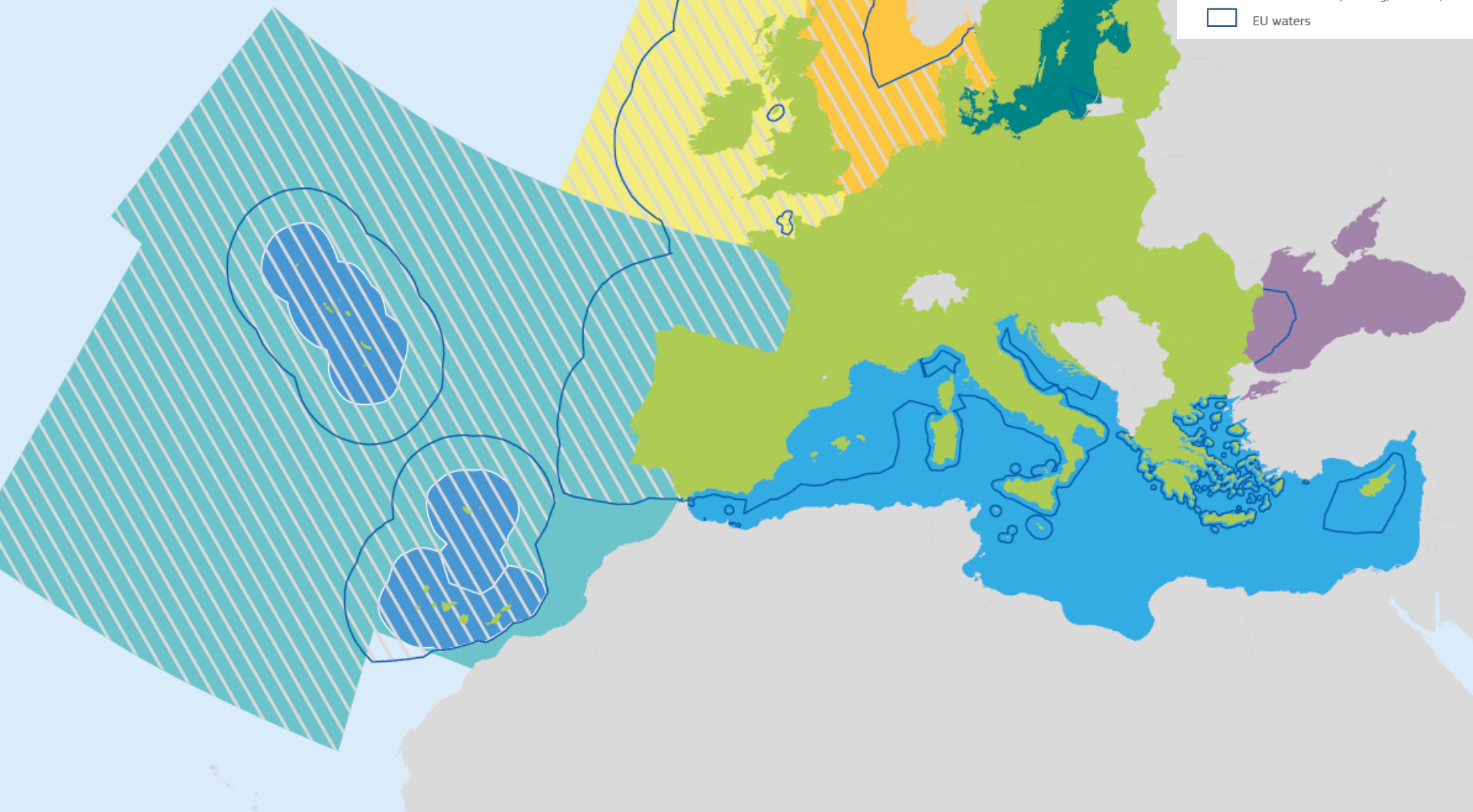



Innovation: Proposal Technical Measures

Article 19: Regional measures under multiannual plans

1. The Commission shall be empowered to establish technical measures at regional level with the aim of achieving objectives of multiannual plans referred to in Articles 9 and 10 of Regulation (EU) No 1380/2013. Such measures shall be established by means of delegated acts adopted in accordance with Article 34 of this Regulation and Article 18 of Regulation (EU) No 1380/2013

5. Where Member States submit joint recommendations for the establishment of technical measures as referred to in paragraph 1, they shall provide scientific evidence to support the adoption of those measures.

Article 24: Innovative fishing gears

1. When Member States submit joint recommendations in accordance with Article 19 to allow for the use of extend the use of innovative fishing gears including the pulse trawl as described in Part E of Annex V within a specific sea basin, they shall provide an assessment of the likely impacts of using such gears on the targeted species and on sensitive species and habitats.

2. Those assessments shall be evaluated by the STECF.

3. The use of innovative fishing gears shall not be permitted where those assessments indicate that their use will lead to negative impacts on sensitive habitats and non-target species.



What could the implementation of pulse have looked like in an ideal situation?

1. Research by the Netherlands
2. Proposal by Netherlands in Scheveningen Group
3. Consultation of the North Sea Advisory Council
4. Joint Recommendation by Scheveningen Group
5. Assessment by STECF
6. Delegated act by Commission



Ideal situation vs. reality

INNOVATION

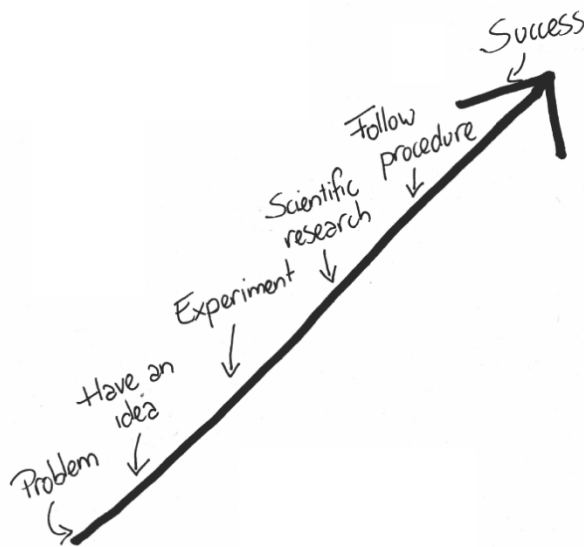

**WHAT PEOPLE THINK
IT LOOKS LIKE**

INNOVATION

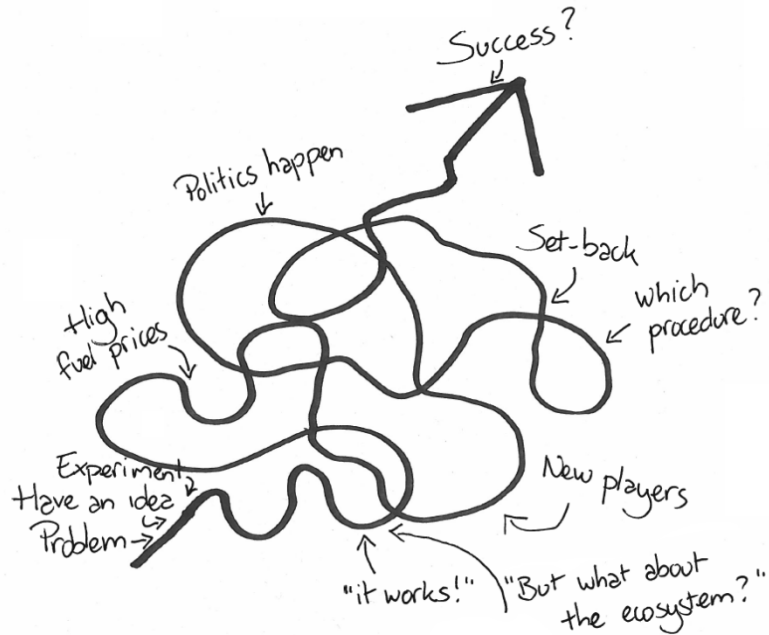

**WHAT IT REALLY
LOOKS LIKE**



Why is pulse fishery important for the Netherlands?

Seabed disturbance...



Large number of discards...

... and high fuel consumption

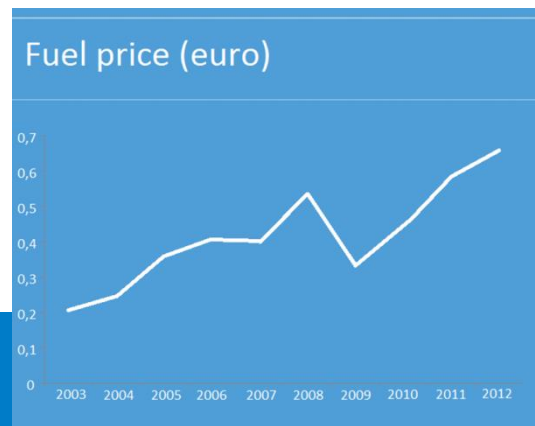



We needed innovation

Innovation has led to diversification in the Dutch flatfish fleet:

- Flyshoot: good for catching gurnard, red mullet and squid
- Sumwing: good for catching plaice, less good for sole
- Twinrig: good for catching plaice and nephrops
- Pulse: good for catching sole and shrimps

- Puls Fisheries was and at the moment still is the main alternative for beam trawl fisheries on sole.



What is the discussion about?

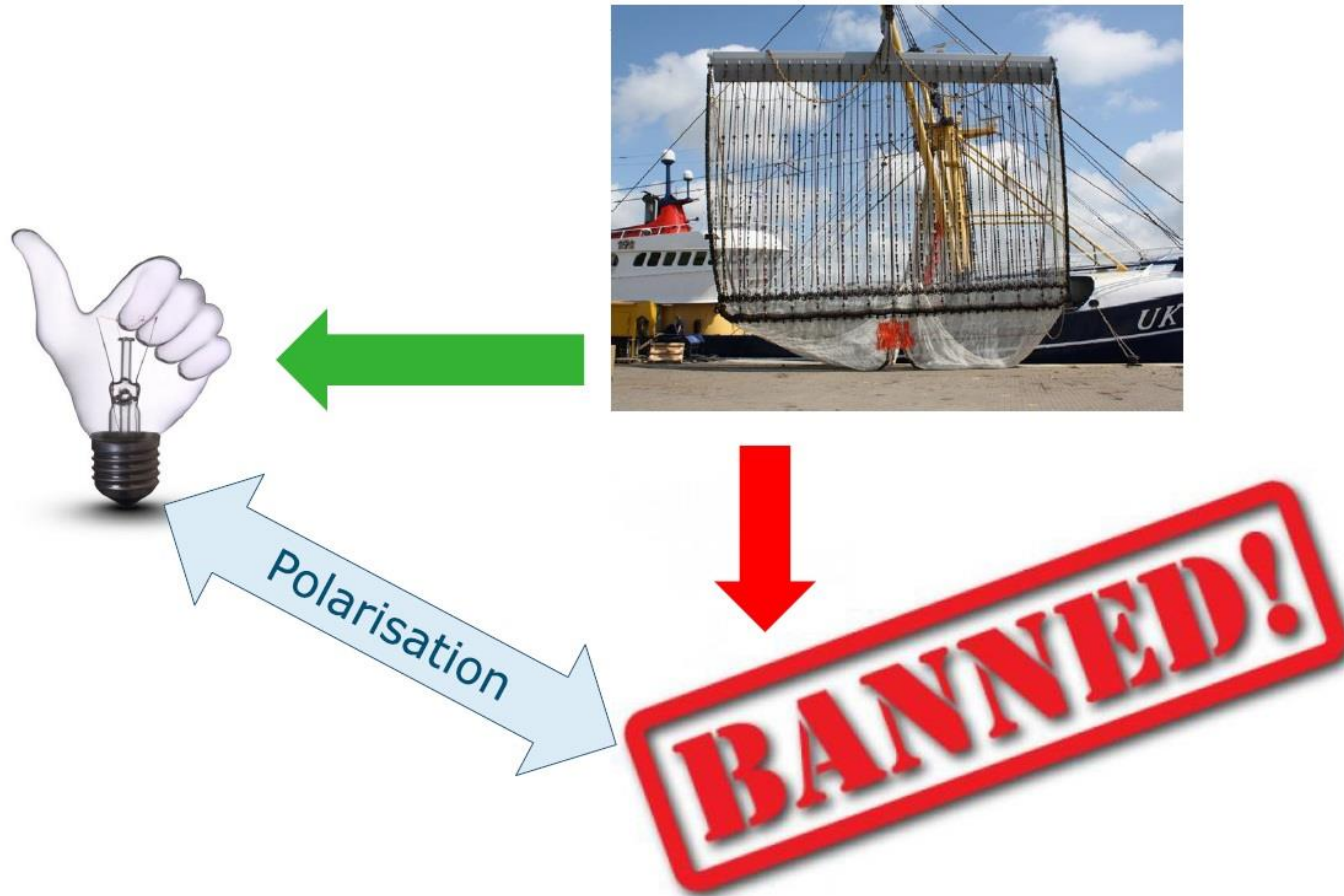



And then things become tricky

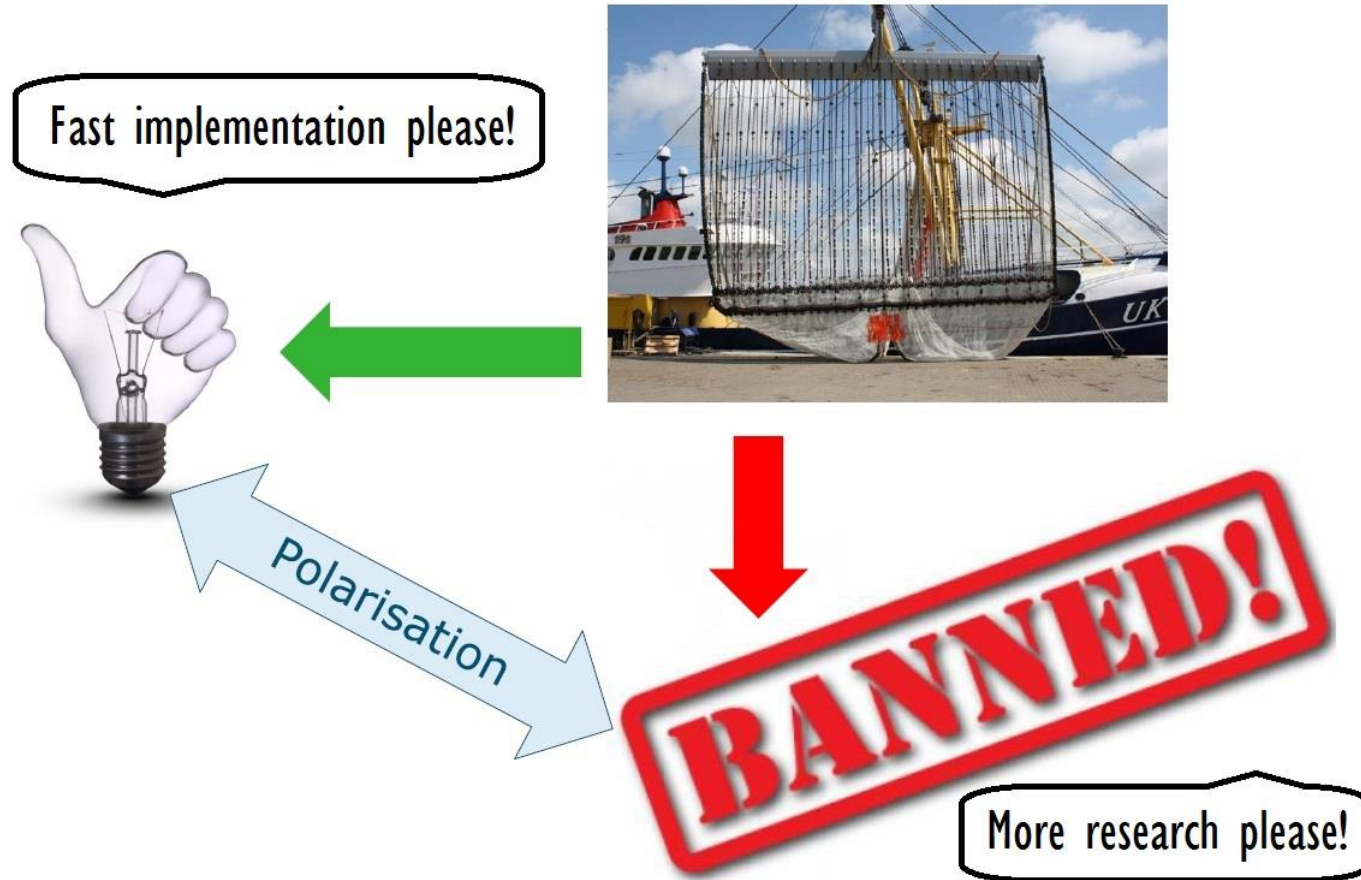



Lessons learned

What went wrong?

- Fundamental research started too late
- Too strong push for expansion from the Netherlands
- Lack of transparency and common approach
- It is hard to stop/slow down an innovation when the economic succes of a fishery depends on it

Things we can build on further

- Fundamental research has started
- Control system is in place
- Strong willingness within the industry to co-operate with research



SCENARIO – WHAT IF

Innovation, what it really looks like & regionalisation

Problem: high fuel price, high bycatch rate, impact on seabed

Have an idea: make fishing gear lighter – pulse, use electricity?!

2007: regionalisation is already in place

Instead of exemption for experimenting with pulse in regulations:

- Discussions with Scheveningen Group, and Advisory Councils
- Gives option to enact quickly
- High transparency level from beginning onwards



[creatieve manier van discussievoeren]

- What role can regionalisation play in innovations?
- How can you be prepared for all that comes on the path during development of the innovation?
- Looking back at development of pulse innovation, what could have been done differently?
-





More info? → www.pulsefishing.eu

Annex 8 Technical requirements pulse trawl

Updated pulse requirements:

1. Fishing with electric current using a beam trawl is only permitted in ICES zones IVc and IVb, south of the latitude 55° N.
2. The Technical On-board Dossier (TOD), which must be prepared in accordance with Enclosure I, is present on board. Furthermore, a Manufacturers' Technical Dossier (MTD) must also be prepared for the pulse fishing gear in accordance with Enclosure II.
3. The fishing gear must comply with the following regulations:
 - a. The peak voltage of the pulse must not exceed 60V, measured between the connections of the electrodes and pulse modules.
 - b. The maximum effective output power must not exceed 1kW per metre of beam length, measured between the connections of the electrodes and pulse modules.
 - c. The composition of the electrodes (item ix) of the fishing gear has been recorded in the MTD by the manufacturer. The other specifications included below are included in both the MTD and the TOD:
 - i. the overall length of the electrode
 - measured from the start of the first conductive part to the end of the last conductive part, not exceeding 4.75 metres;
 - ii. the number of conductive parts per electrode
 - at least 6 parts and no more than 12 parts;
 - iii. minimum and maximum thickness of the conductive part of the electrode (mm)
 - diameter (circular) no more than 40 mm (minimum dimensions due to limitation of maximum individual deviations in order to remain compliant with the conditions for testing in laboratory conditions);
 - iv. minimum and maximum length of the conductive part of the electrode (mm)
 - at least 125 mm and no more than 200 mm;
 - v. minimum and maximum length of the leading insulator (m)
 - at least two metres;
 - vi. number and length of insulated parts per electrode;
 - vii. The individual distance between the electrodes (mm) attached to the wing/beam
 - at least 400 mm centre to centre;
 - viii. the diameter of the steel wire of the electrodes (mm)
 - no more than 20 mm;
 - ix. the composition of the electrode (in MTD)
 - make-up and materials used.
 - d. The pulse setting is between 20 and 180 pulses per second.
 - e. The live part of the pulse period (the duty cycle) should not exceed 3.0%.
 - f. The electrode pairs are not activated at the same time as the neighbouring electrodes to keep the generated field stable.
 - g. The width of the whole field generated by the gear, measured as the horizontal distance between the two outermost electrodes perpendicular to the electrode direction, should not exceed the width of the fishing net, with a maximum of 12 metres.
4. The vessel is equipped with an automatic computer management system, including a data logger, which is described in the MTD by the manufacturer.
5. The data in the system cannot be manipulated. Apart from the enforcing authorities, or their mandatory, and the manufacturer, nobody has access to the computer management system to modify it. The system registers all the data stated below for at least the last 6 months and at least the last 100 tows.
 - a. The system registers all the times when the data is read.
 - b. The system registers whether the fishing gear has been powered up or down, linked to the exact time and position, in order to register if fishing has been carried out in the permitted zones.
 - c. The system registers the peak voltage referred to under 3a and the effective power referred to under 3b, constructing a diagram per tow depicting the voltage on the

12 december 2016

Ministry of Economic Affairs

Translated Pulse requirements (voorschriften) - English

electrode pairs. Here, at least one sample/minute is used as the result of a moving average. This diagram is supplied in hard copy or digital form.

- d. The instruction in 5c does not apply if the peak voltage referred to under 3a and the effective power referred to under 3b are automatically subjected to respective maximums of 60V and 1kW/metre. The units subjected to a maximum are certified by an accredited institution. This involves a type certification.
 - e. The system registers the pulse settings that have been used for fishing.
6. The diagram referred to under 5c is issued to the enforcing authorities at their request.
 7. No tickler chains or other fish-stimulating facilities may be attached in front of the footrope.
 8. A net with floating voltage is used on the vessel to supply power to the pulse system.
 9. Assistance will be provided for the monitoring programme into the effects of pulse fishing that is being performed as a collaboration between the Ministry of Economic Affairs, the fisheries sector and the research institutes. This assistance may consist of financial contributions to the programme costs.
 10. The following fishing gear codes are used in the log:

Name of fishing gear	Code to be recorded in the log
Pulse trawl	PUK
Pulse wing	PUL

11. The Sea Fishing Implementing Regulations are being met.

The following parts of the pulse fishing gear are subject to a transition period:

- Electrodes must comply with the above requirements by 1 March 2017 at the latest. Electrodes can be replaced with new ones in the interim.
- Modules must comply with the above requirements by 1 March 2018 at the latest.

The pulse permission may be suspended or withdrawn if a fisherman fails to comply with the requirements as set above.

This permission must be present on board the vessel for which the permission has been granted while fishing and must be presented immediately upon request by any official responsible for inspection.

Wageningen Marine Research
T +31 (0)317 48 09 00
E: marine-research@wur.nl
www.wur.eu/marine-research

Visitors' address

- Ankerpark 27 1781 AG Den Helder
- Korringaweg 5, 4401 NT Yerseke
- Haringkade 1, 1976 CP IJmuiden



Wageningen Marine Research is the Netherlands research institute established to provide the scientific support that is essential for developing policies and innovation in respect of the marine environment, fishery activities, aquaculture and the maritime sector.

Wageningen University & Research:

is specialised in the domain of healthy food and living environment.

The Wageningen Marine Research vision

'To explore the potential of marine nature to improve the quality of life'

The Wageningen Marine Research mission

- To conduct research with the aim of acquiring knowledge and offering advice on the sustainable management and use of marine and coastal areas.
- Wageningen Marine Research is an independent, leading scientific research institute

Wageningen Marine Research is part of the international knowledge organisation Wageningen UR (University & Research centre). Within Wageningen UR, nine specialised research institutes of the Stichting Wageningen Research Foundation have joined forces with Wageningen University to help answer the most important questions in the domain of healthy food and living environment.
